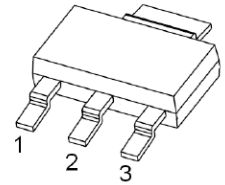

## SOT-223(8R) Plastic-Encapsulate Transistors

### BCP51,52,53 TRANSISTOR (PNP)

#### FEATURES

- For AF driver and output stages
- High collector current
- Low collector-emitter saturation voltage
- Complementary types: BCP54...BCP56 (NPN)

**SOT-223**

1. BASE
2. COLLECTOR
3. EMITTER

#### MAXIMUM RATINGS ( $T_a=25^\circ\text{C}$ unless otherwise noted)

Symbol	Parameter	BCP51	BCP52	BCP53	Unit
$V_{CBO}$	Collector-Base Voltage	-45	-60	-100	V
$V_{CEO}$	Collector-Emitter Voltage	-45	-60	-80	V
$V_{EBO}$	Emitter-Base Voltage		-5		V
$I_C$	Collector Current -Continuous		-1		A
$I_{CM}$	Peak Pulse Collector Current		-2		A
$I_B$	Base Current-Continuous		-100		mA
$I_{BM}$	Peak Pulse Base Current		-200		mA
$P_C$	Collector Power Dissipation		1.5		W
$T_J, T_{stg}$	Operation Junction and Storage Temperature Range		-55~+150		$^\circ\text{C}$
$R_{\theta JA}$	Thermal Resistance Junction to Ambient		94		$^\circ\text{C/W}$

#### ELECTRICAL CHARACTERISTICS ( $T_a=25^\circ\text{C}$ unless otherwise specified)

Parameter	Symbol	Test conditions	Min	Max	Unit
Collector-base breakdown voltage	BCP51	$I_C = -0.1\text{mA}, I_E = 0$	-45		V
	BCP52		-60		
	BCP53		-100		
Collector-emitter breakdown voltage	BCP51	$I_C = -10\text{mA}, I_B = 0$	-45		V
	BCP52		-60		
	BCP53		-80		
Base-emitter breakdown voltage	$V_{(BR)EBO}$	$I_E = -10\mu\text{A}, I_C = 0$	-5		V
Collector cut-off current	$I_{CBO}$	$V_{CB} = -30\text{V}, I_E = 0$		-100	nA
DC current gain	$h_{FE(1)}$	$V_{CE} = -2\text{V}, I_C = -5\text{mA}$	25		
	$h_{FE(2)}$	$V_{CE} = -2\text{V}, I_C = -150\text{mA}$	63	250	
	$h_{FE(3)}$	$V_{CE} = -2\text{V}, I_C = -500\text{mA}$	25		
Collector-emitter saturation voltage	$V_{CE(sat)}$	$I_C = -500\text{mA}, I_B = -50\text{mA}$		-0.5	V
Base-emitter voltage	$V_{BE}$	$V_{CE} = -2\text{V}, I_C = -500\text{mA}$		-1	V
Transition frequency	$f_T$	$V_{CE} = -10\text{V}, I_C = -50\text{mA}, f = 100\text{MHz}$	100		MHz

#### CLASSIFICATION OF $h_{FE(2)}$

Rank	BCP51-10, BCP52-10, BCP53-10	BCP51-16, BCP52-16, BCP53-16
Range	63-160	100-250

# Typical Characteristics

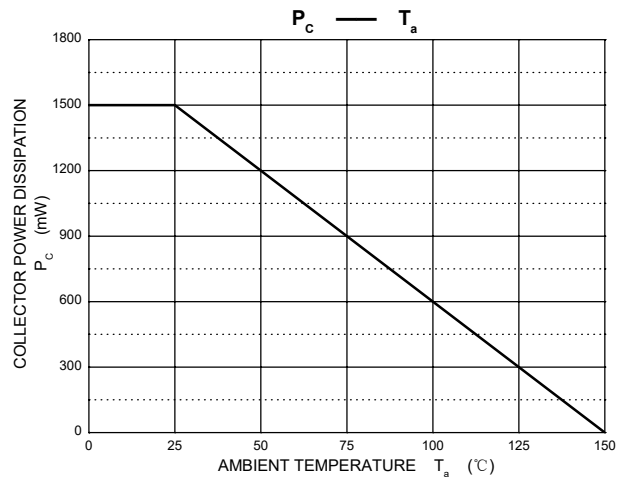
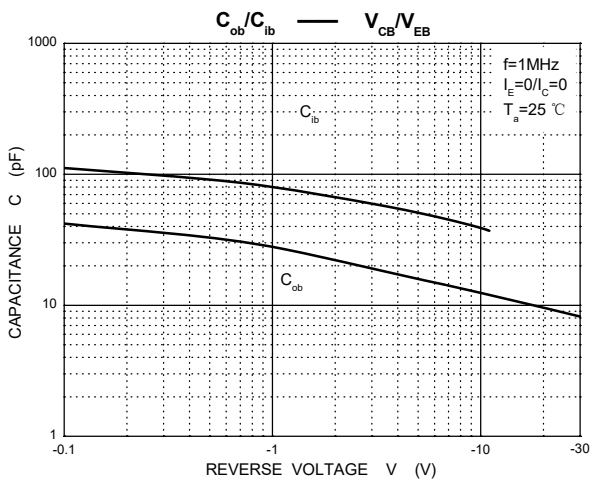
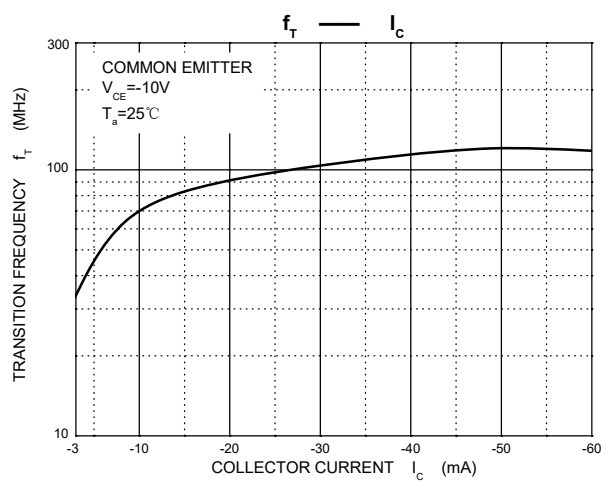
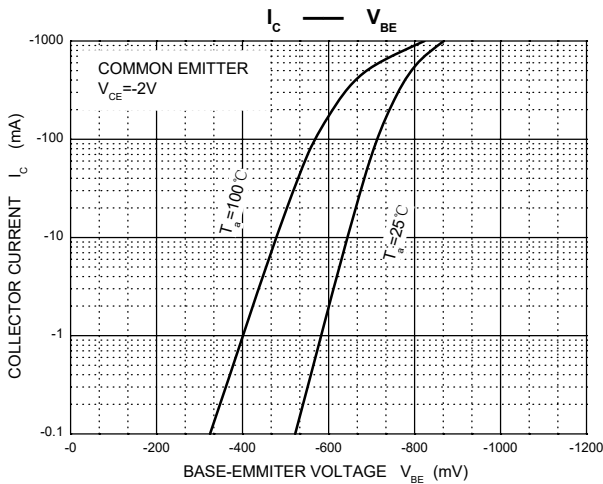
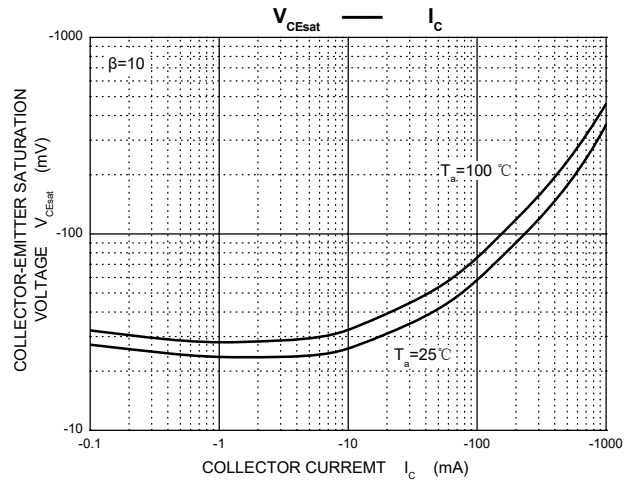
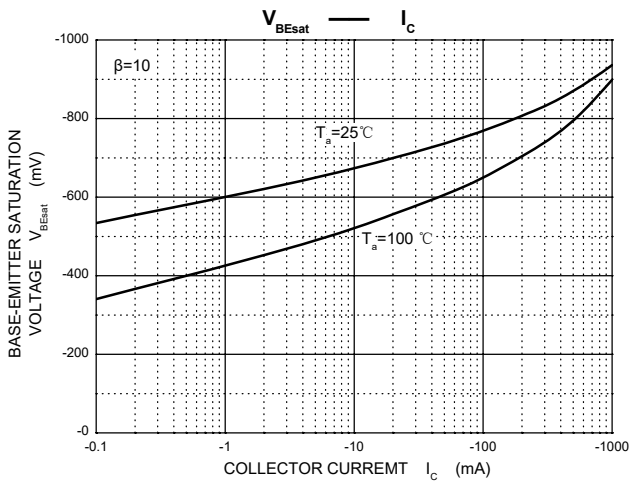
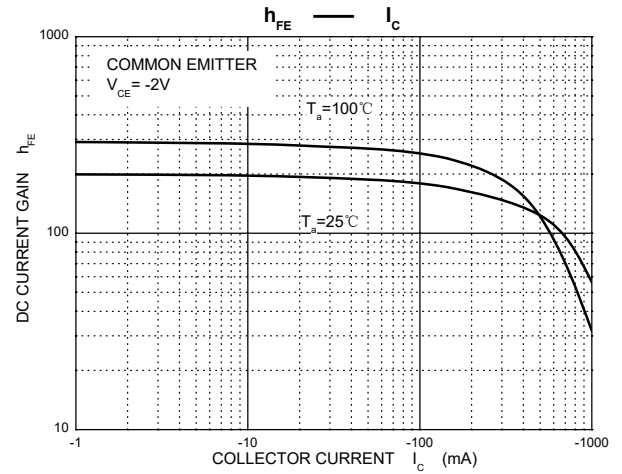
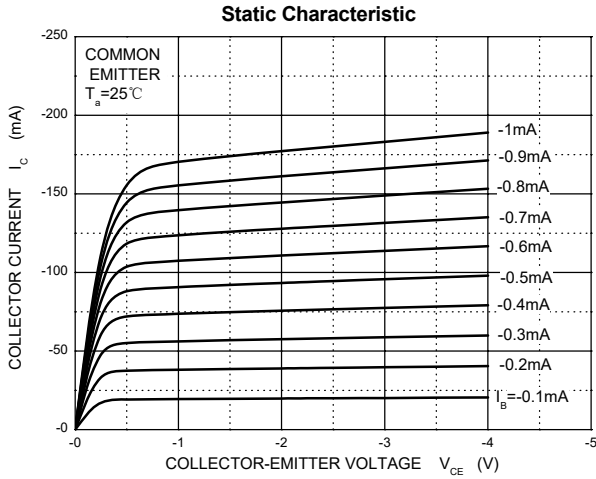

## SOT-223 Package Outline Dimensions

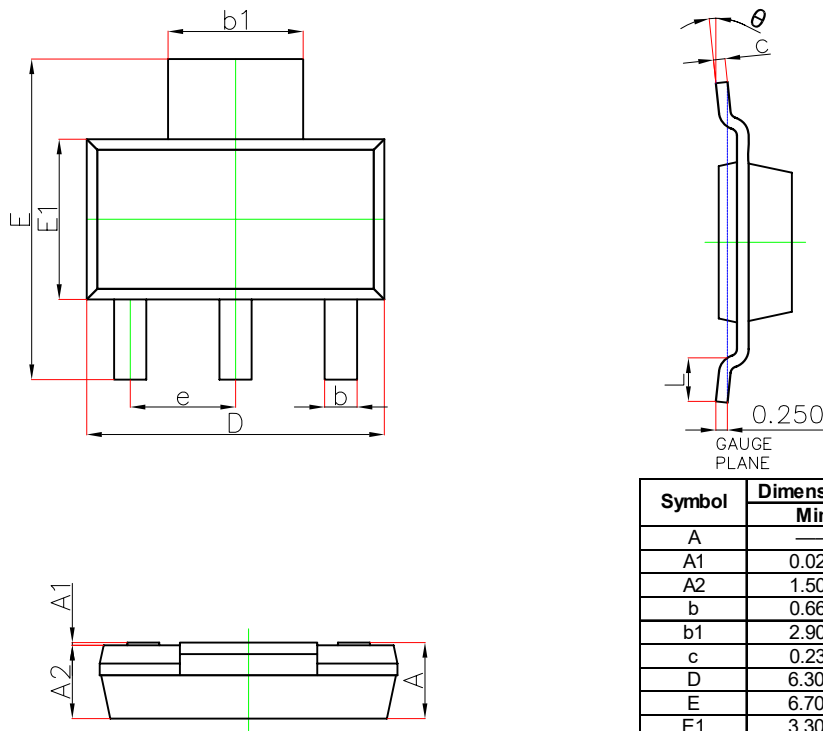

Symbol	Dimensions In Millimeters		Dimensions In Inches	
	Min.	Max.	Min.	Max.
A	—	1.800	—	0.071
A1	0.020	0.100	0.001	0.004
A2	1.500	1.700	0.059	0.067
b	0.660	0.840	0.026	0.033
$b_1$	2.900	3.100	0.114	0.122
c	0.230	0.350	0.009	0.014
D	6.300	6.700	0.248	0.264
E	6.700	7.300	0.264	0.287
E1	3.300	3.700	0.130	0.146
e	2.300(BSC)		0.091(BSC)	
L	0.750	—	0.030	—
$\theta$	0°	10°	0°	10°

## SOT-223 Suggested Pad Layout

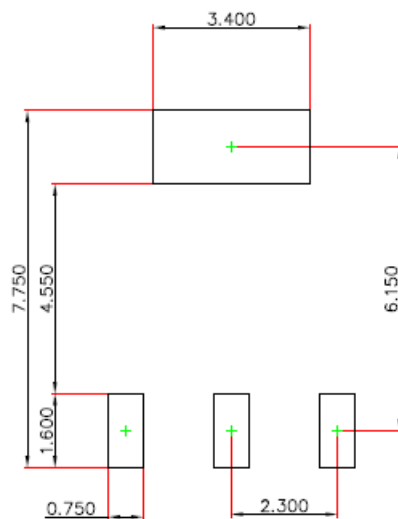

### Note:

1. Controlling dimension: in millimeters.
2. General tolerance:  $\pm 0.050$  mm.
3. The pad layout is for reference purposes only.

### NOTICE

JSCJ reserves the right to make modifications, enhancements, improvements, corrections or other changes without further notice to any product herein. JSCJ does not assume any liability arising out of the application or use of any product described herein.

# SOT-223 Tape and Reel

## SOT-223 Embossed Carrier Tape

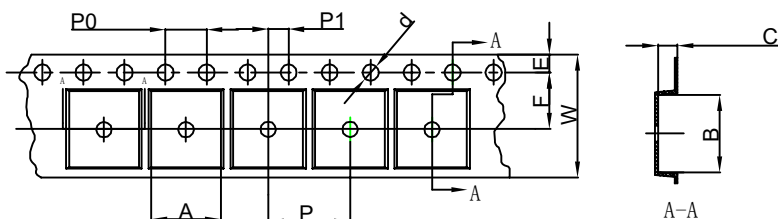

**Packaging Description:**  
 SOT-223 parts are shipped in tape. The carrier tape is made from a dissipative (carbon filled) polycarbonate resin. The cover tape is a multilayer film (Heat Activated Adhesive in nature) primarily composed of polyester film, adhesive layer, sealant, and anti-static sprayed agent. These reeled parts in standard option are shipped with 2,500 units per 13" or 33.0cm diameter reel. The reels are clear in color and is made of polystyrene plastic (anti-static coated).

Dimensions are in millimeter										
Pkg type	A	B	C	d	E	F	P0	P	P1	W
SOT-223	6.765	7.335	1.88	Ø1.50	1.75	5.50	4.00	8.00	2.00	12.00

## SOT-223 Tape Leader and Trailer

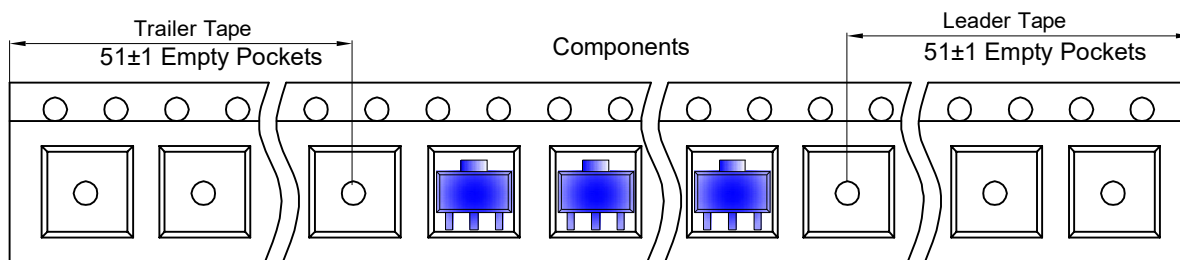

## SOT-223 Reel

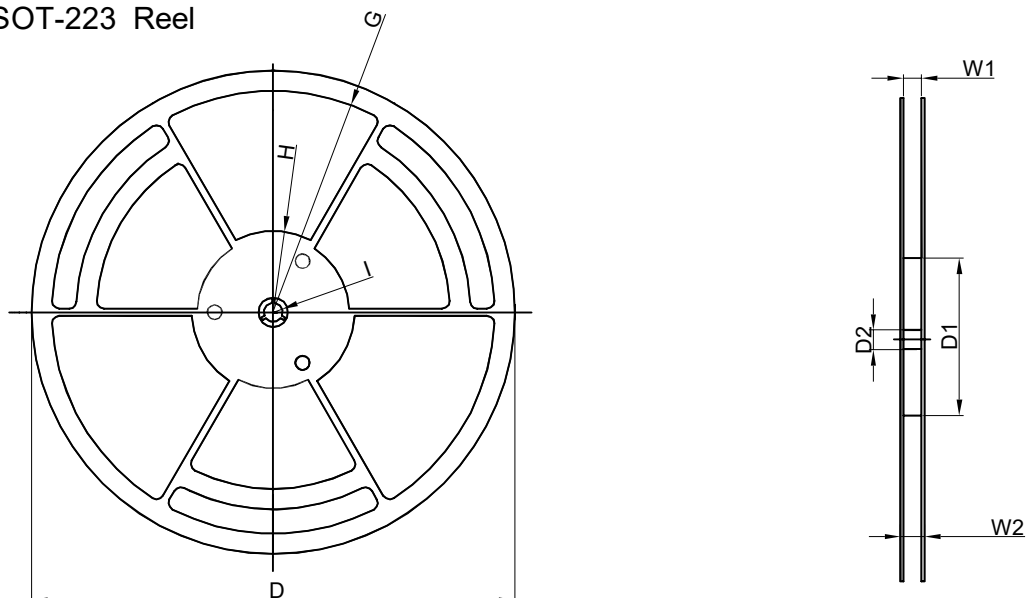

Dimensions are in millimeter								
Reel Option	D	D1	D2	G	H	I	W1	W2
13" Dia	Ø330.00	100.00	13.00	R151.00	R56.00	R6.50	12.40	17.60

REEL	Reel Size	Box	Box Size(mm)	Carton	Carton Size(mm)	G.W.(kg)
2,500 pcs	13 inch	2,500 pcs	336×336×48	20,000 pcs	445×355×365	