

Features

- 2.3V to 6.6V operating input voltage
- Up to 250mA output current capability
- Fixed output voltage range: 0.9V, 1.05V, 1.2V, 1.5V, 1.8V, 2.5V, 2.7V, 3.0V, 3.3V and 3.6V with $\pm 2\%$ accuracy
- Ultra low input consumption current: 1.35 μ A (typical)
- Stable with 1 μ F ceramic output capacitor
- Fast output discharge to ground when shutdown
- Soft-start function when powered on
- High PSRR: 75dB at 1kHz
- Low output noise: 50 μ V_{RMS} from 10Hz to 100kHz
- Over current and over temperature protection features
- Enable/disable function
- Package types: 4-pin DFN, 5-pin SOT23 and 3-pin SOT89

Applications

- IoT devices
- Smart/Health wearable devices

General Description

The HT73Lxx are a series of low dropout voltage regulators with an input voltage range from 2.3V to 6.6V. They are available in a range of fixed output voltages from 0.9V to 3.6V. When the CE pin input is low, a fast discharge path pulls the output voltage low via an internal pull-down resistor. An internal over-current protection circuit prevents the devices from damage even if their output was shorted to ground. An over-temperature protection circuit ensures the device junction temperature will not exceed a temperature of 150°C.

Due to the device's outstanding PSRR and low output noise performance features, they are suitable for use in powering RF applications such as sub-1GHz transceivers. Their ultra-small 4-pin DFN package type with their 0.4mm thickness makes the devices also suitable for space limited applications such as financial/credit cards or smart wearable products.

Selection Table

Part No.	Output Voltage	Package Type	Marking
HT73L09	0.9V	4DFN SOT23-5 SOT89	xx for 4DFN type 3Lxx for SOT23-5 type HT73Lxx for SOT89 type
HT73L10	1.05V		
HT73L12	1.2V		
HT73L15	1.5V		
HT73L18	1.8V		
HT73L25	2.5V		
HT73L27	2.7V		
HT73L30	3.0V		
HT73L33	3.3V		
HT73L36	3.6V		

Note: "xx" stands for output voltages

Block Diagram

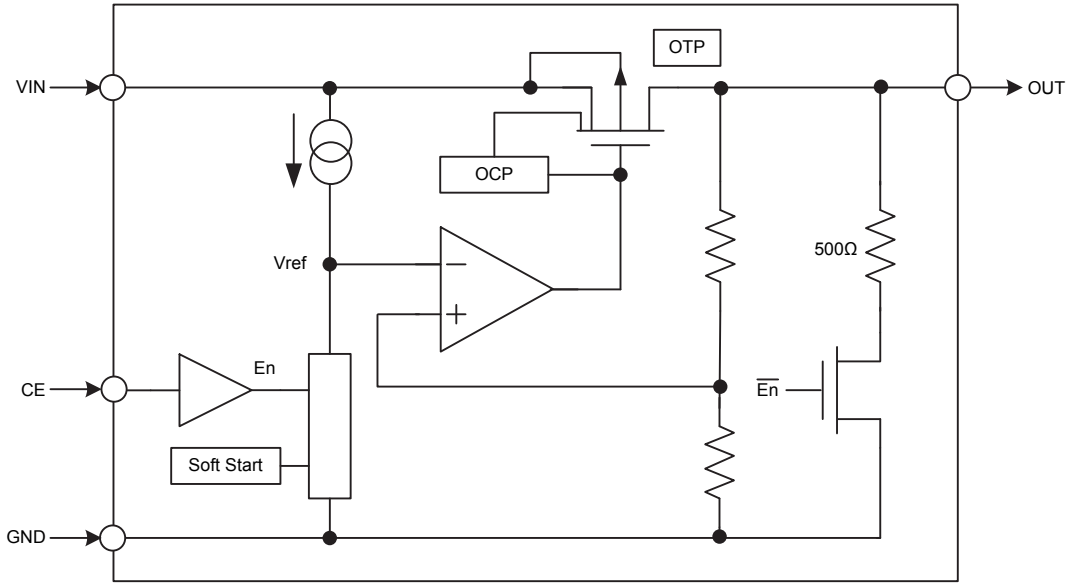

Pin Assignment

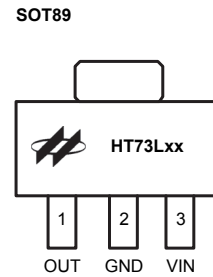
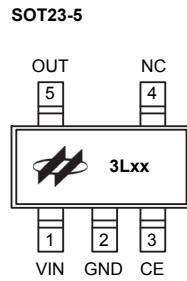
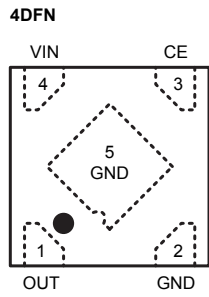

Pin Description

Pin No.			Pin Name	Pin Description
4DFN	SOT23-5	SOT89		
1	5	1	OUT	Output pin
2	2	2	GND	Ground pin
3	3		CE	Chip enable pin, active high. This pin must not be allowed to float. It should be connected to VIN if not used
4	1	3	VIN	Input pin
	4		NC	Not connected

Absolute Maximum Ratings

Parameter	Value	Unit
V_{IN}	-0.3 to +7.0	V
V_{CE}	-0.3 to ($V_{IN}+0.3$)	V
Operating Temperature Range, T_a	-40 to +85	°C
Maximum Junction Temperature, $T_{j,max}$	+150	°C
Storage Temperature Range	-65 to +165	°C
Junction-to-Ambient Thermal Resistance, θ_{JA}	4DFN	250
	SOT23-5	500
	SOT89	200
Power Dissipation, P_D	4DFN	0.5
	SOT23-5	0.25
	SOT89	0.625

Note: P_D is measured at $T_a=25^\circ\text{C}$

Recommended Operating Range

Parameter	Value	Unit
V_{IN}	2.3 to 6.6	V
V_{CE}	0 to V_{IN}	V

Electrical Characteristics

 $V_{IN}=(V_{OUT}+1V)$, $V_{CE}=V_{IN}$, $I_{OUT}=10mA$, $T_a=25^{\circ}C$ and $C_{IN}=C_{OUT}=1\mu F$, unless otherwise specified

Symbol	Parameter	Test Conditions	Min.	Typ.	Max.	Unit
V_{IN}	Input Voltage	—	2.3	—	6.6	V
V_{OUT}	Output Voltage Range	—	0.9	—	3.6	V
V_O	Output Voltage Accuracy	$I_{OUT}=1mA$	-2	—	2	%
I_{OUT}	Output Current	$V_{IN}\geq 2.3V$	250	—	—	mA
$\frac{\Delta V_{OUT}}{V_{OUT}}$	Load Regulation	$1mA\leq I_{OUT}\leq 200mA$	—	0.5	1.0	%
V_{DIF}	Dropout Voltage (Note)	$V_{OUT}<1.2V$, $I_{OUT}=50mA$, V_{OUT} Change=2%	—	320	500	mV
		$1.2V\leq V_{OUT}<1.5V$, $I_{OUT}=50mA$, V_{OUT} Change=2%	—	270	400	
		$1.5V\leq V_{OUT}<1.8V$, $I_{OUT}=50mA$, V_{OUT} Change=2%	—	160	240	
		$1.8V\leq V_{OUT}<2.5V$, $I_{OUT}=50mA$, V_{OUT} Change=2%	—	120	180	
		$2.5V\leq V_{OUT}<3.0V$, $I_{OUT}=50mA$, V_{OUT} Change=2%	—	100	150	
		$3.0V\leq V_{OUT}$, $I_{OUT}=50mA$, V_{OUT} Change=2%	—	75	130	
I_{SS}	Quiescent Current	$V_{IN}=4.2V$, $I_{OUT}=0mA$	—	1.35	2.50	μA
I_{SHD}	Shutdown Current	$V_{CE}=0V$	—	0.01	0.10	μA
$\frac{\Delta V_{OUT}}{\Delta V_{IN} \times V_{OUT}}$	Line Regulation	$(V_{OUT}+1V)\leq V_{IN}\leq 6.0V$, $I_{OUT}=10mA$	—	0.02	0.10	%/V
$\frac{\Delta V_{OUT}}{\Delta T_a \times V_{OUT}}$	Temperature Coefficient	$I_{OUT}=10mA$, $-40^{\circ}C<T_a<85^{\circ}C$	—	± 100	—	ppm/ $^{\circ}C$
I_{OCP}	OCP Threshold	$V_{IN}=(V_{OUT}+1V)$	—	300	—	mA
T_{OCP}	OCP Debounce Time	—	—	5	—	us
V_{IH}	Enable High Threshold	CE pin, $V_{IN}=6V$	1.2	—	—	V
V_{IL}	Enable Low Threshold	CE pin, $V_{IN}=6V$	—	—	0.4	V
R_{DIS}	Discharge Resistor	Force $V_{IN}=6V$, $CE=0V$ and $V_{OUT}=0.5V$	—	500	—	Ω
T_{SHD}	Shutdown Temperature	—	—	150	—	$^{\circ}C$
T_{REC}	Recovery Temperature	—	—	125	—	$^{\circ}C$
PSRR	Power Supply Rejection Ratio	$V_{OUT}=3.3V$, $I_{OUT}=50mA$, $f=1kHz$	—	75	—	dB
Noise	Output Voltage Noise	$V_{OUT}=3.3V$, $I_{OUT}=30mA$, $BW=10Hz$ to $100kHz$	—	50	—	μV_{RMS}

Note: The dropout voltage is defined as the input voltage minus the output voltage that produces a 2% change in the output voltage from the value at $V_{IN}=V_{OUT}+1V$ with a 50mA fixed load.

* The maximum operation voltage(6.6V) passes 125 $^{\circ}C$ /1000-Hour HToL experiment.

Typical Performance Characteristics

Test Condition: $V_{IN}=V_{OUT}+1V$, $V_{CE}=V_{IN}$, $I_{OUT}=10mA$, $C_{IN}=1\mu F$, $C_{OUT}=1\mu F$ and $T_a=25^\circ C$, unless otherwise noted.

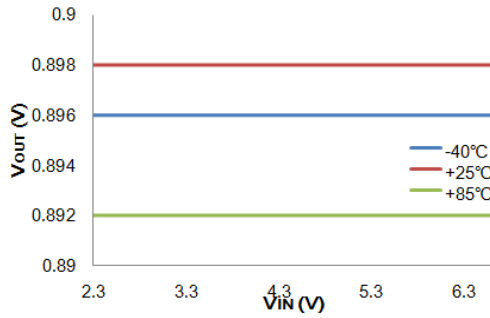

Line Regulation: HT73L09 (I_{OUT}=10mA)

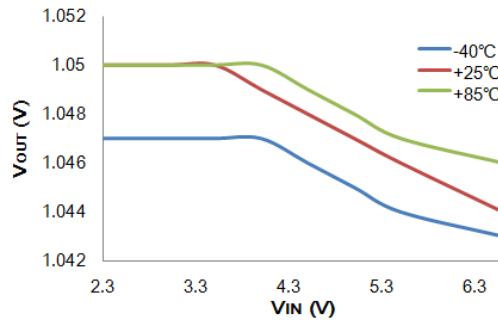

Line Regulation: HT73L10 (I_{OUT}=10mA)

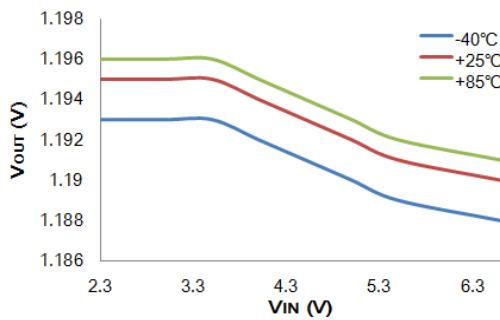

Line Regulation: HT73L12 (I_{OUT}=10mA)

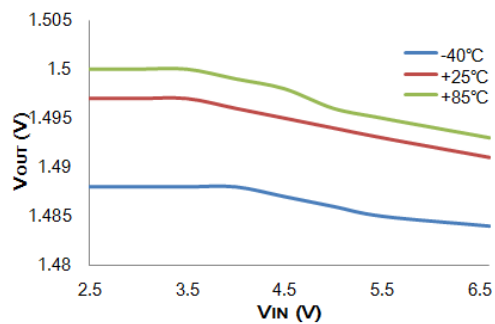

Line Regulation: HT73L15 (I_{OUT}=10mA)

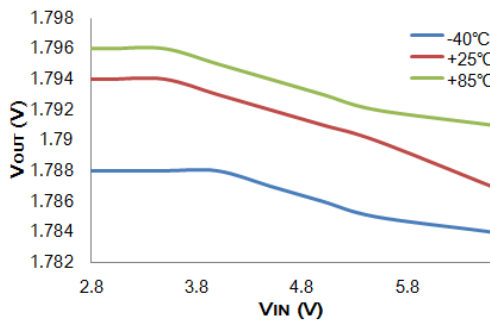

Line Regulation: HT73L18 (I_{OUT}=10mA)

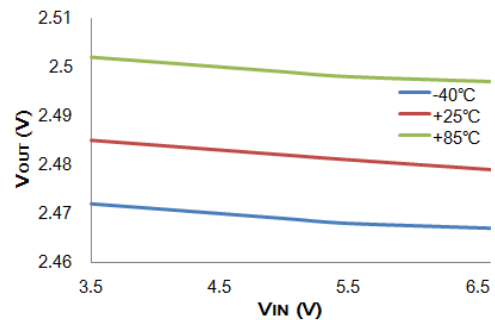

Line Regulation: HT73L25 (I_{OUT}=10mA)

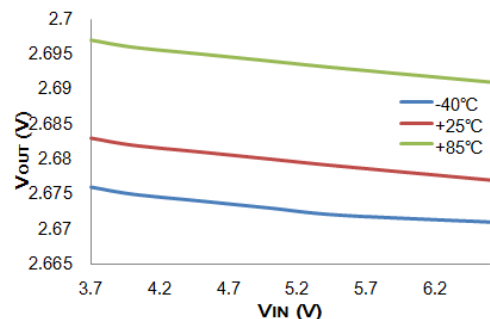

Line Regulation: HT73L27 (I_{OUT}=10mA)

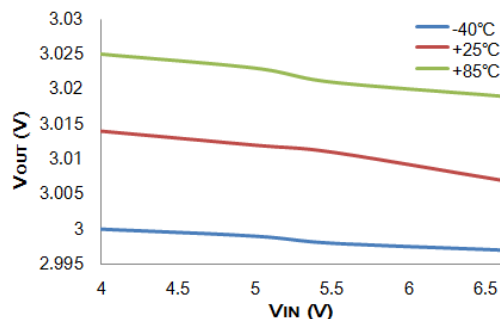

Line Regulation: HT73L30 (I_{OUT}=10mA)

Test Condition: $V_{IN}=V_{OUT}+1V$, $V_{CE}=V_{IN}$, $I_{OUT}=10mA$, $C_{IN}=1\mu F$, $C_{OUT}=1\mu F$ and $T_a=25^\circ C$, unless otherwise noted.

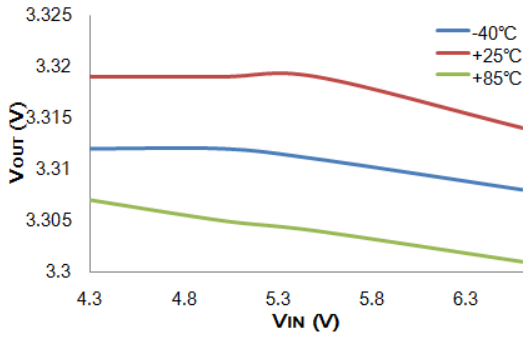

Line Regulation: HT73L33 ($I_{OUT}=10mA$)

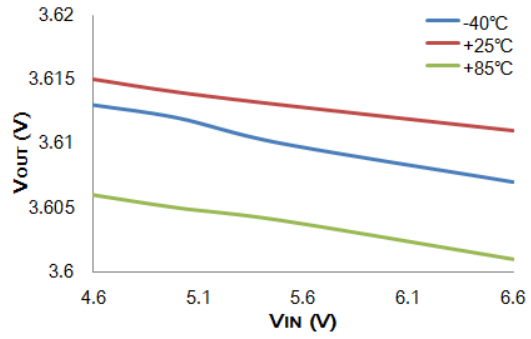

Line Regulation: HT73L36 ($I_{OUT}=10mA$)

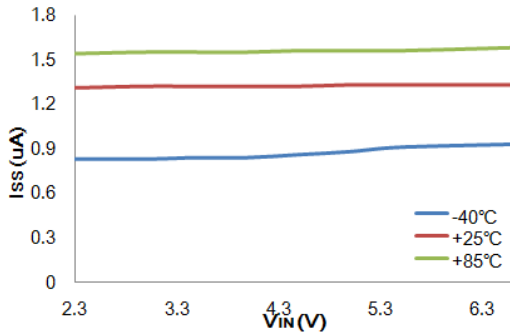

I_{SS} vs V_{IN} : HT73L09 ($I_{OUT}=0mA$)

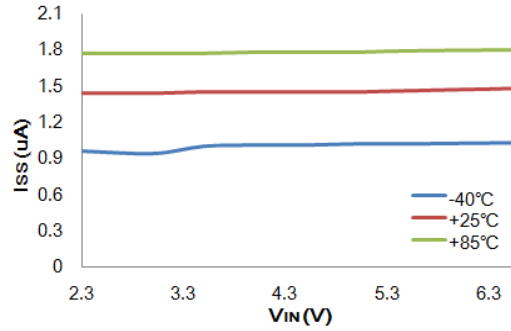

I_{SS} vs V_{IN} : HT73L10 ($I_{OUT}=0mA$)

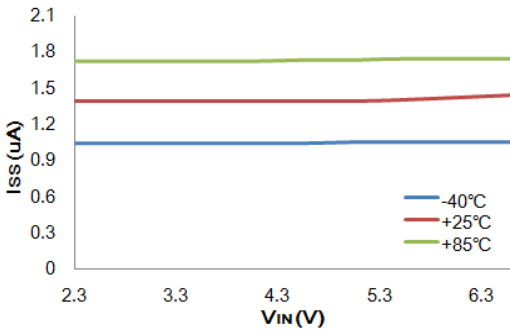

I_{SS} vs V_{IN} : HT73L12 ($I_{OUT}=0mA$)

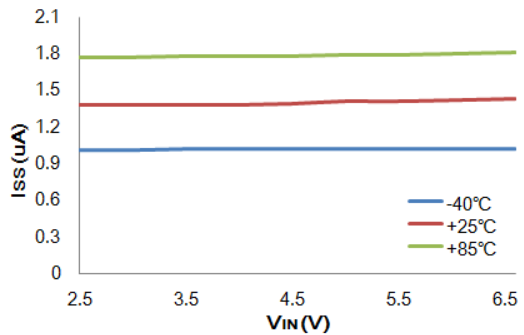

I_{SS} vs V_{IN} : HT73L15 ($I_{OUT}=0mA$)

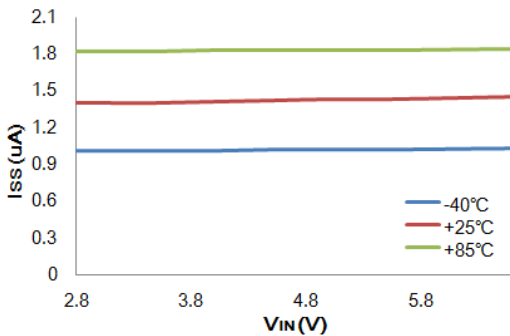

I_{SS} vs V_{IN} : HT73L18 ($I_{OUT}=0mA$)

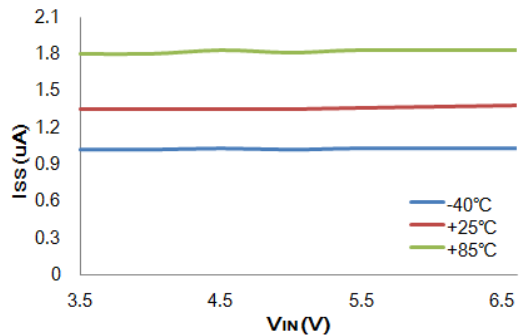

I_{SS} vs V_{IN} : HT73L25 ($I_{OUT}=0mA$)

Test Condition: $V_{IN}=V_{OUT}+1V$, $V_{CE}=V_{IN}$, $I_{OUT}=10mA$, $C_{IN}=1\mu F$, $C_{OUT}=1\mu F$ and $T_a=25^\circ C$, unless otherwise noted.

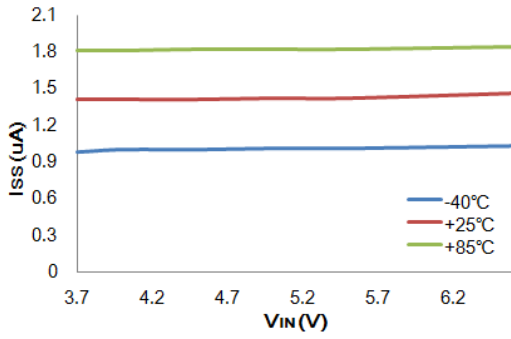

I_{SS} vs V_{IN} : HT73L27 ($I_{OUT}=0mA$)

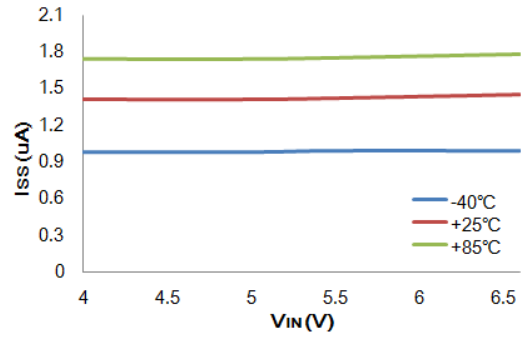

I_{SS} vs V_{IN} : HT73L30 ($I_{OUT}=0mA$)

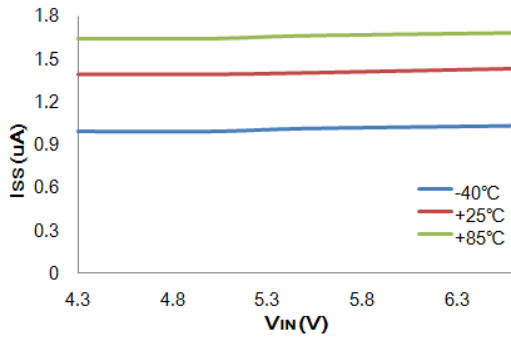

I_{SS} vs V_{IN} : HT73L33 ($I_{OUT}=0mA$)

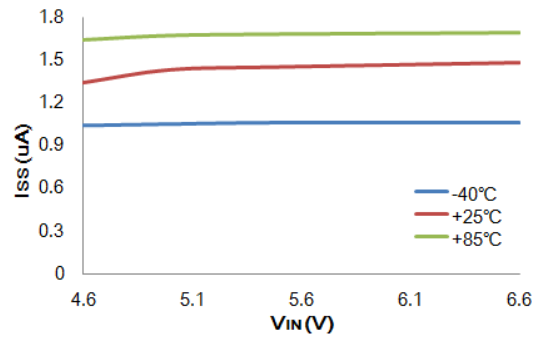

I_{SS} vs V_{IN} : HT73L36 ($I_{OUT}=0mA$)

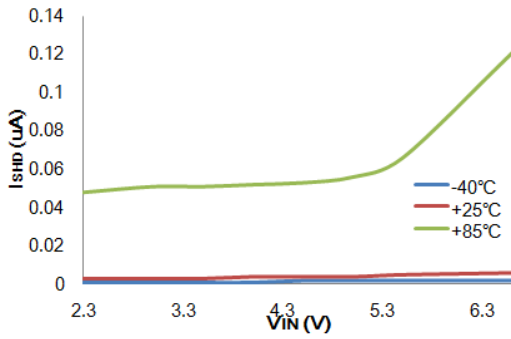

I_{SHD} vs V_{IN} : HT73L09 ($I_{OUT}=0mA$)

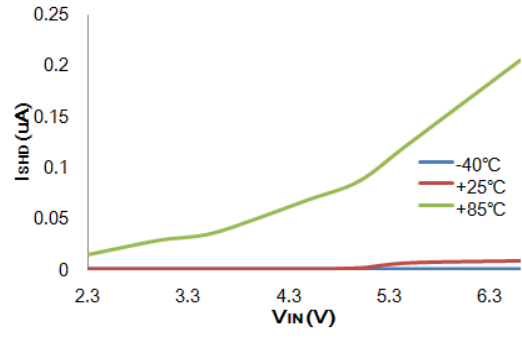

I_{SHD} vs V_{IN} : HT73L10 ($I_{OUT}=0mA$)

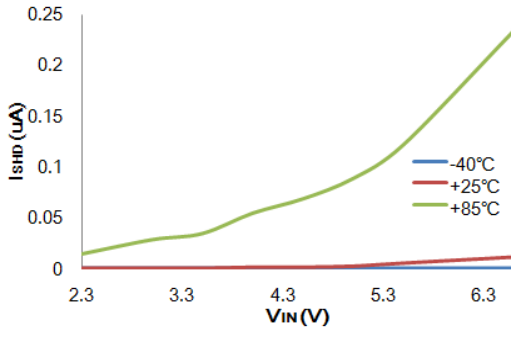

I_{SHD} vs V_{IN} : HT73L12 ($I_{OUT}=0mA$)

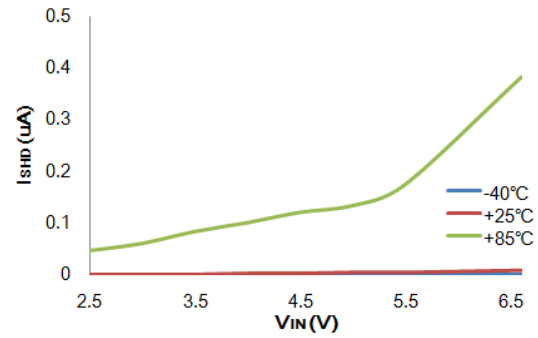

I_{SHD} vs V_{IN} : HT73L15 ($I_{OUT}=0mA$)

Test Condition: $V_{IN}=V_{OUT}+1V$, $V_{CE}=V_{IN}$, $I_{OUT}=10mA$, $C_{IN}=1\mu F$, $C_{OUT}=1\mu F$ and $T_a=25^\circ C$, unless otherwise noted.

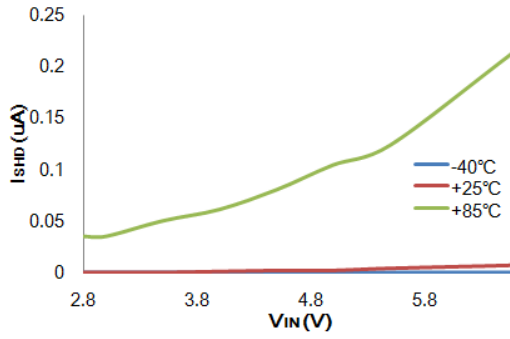

I_{SHD} vs V_{IN} : HT73L18 ($I_{OUT}=0mA$)

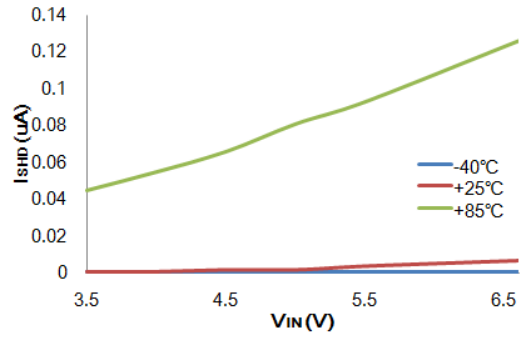

I_{SHD} vs V_{IN} : HT73L25 ($I_{OUT}=0mA$)

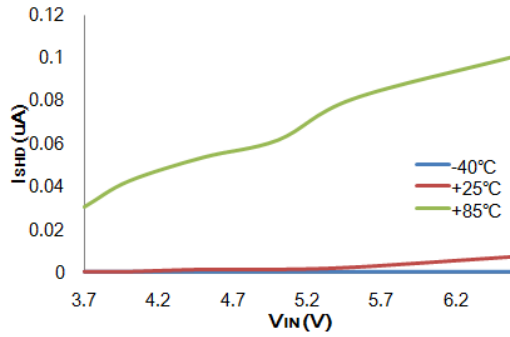

I_{SHD} vs V_{IN} : HT73L27 ($I_{OUT}=0mA$)

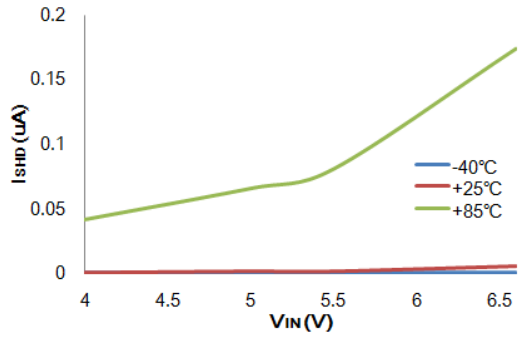

I_{SHD} vs V_{IN} : HT73L30 ($I_{OUT}=0mA$)

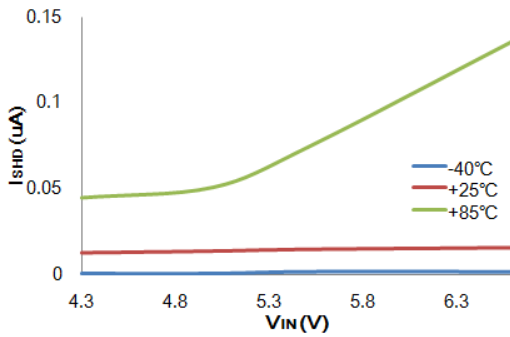

I_{SHD} vs V_{IN} : HT73L33 ($I_{OUT}=0mA$)

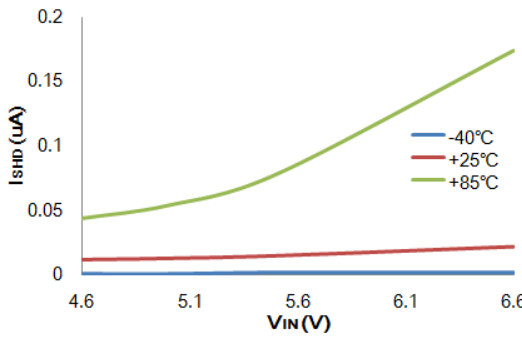

I_{SHD} vs V_{IN} : HT73L36 ($I_{OUT}=0mA$)

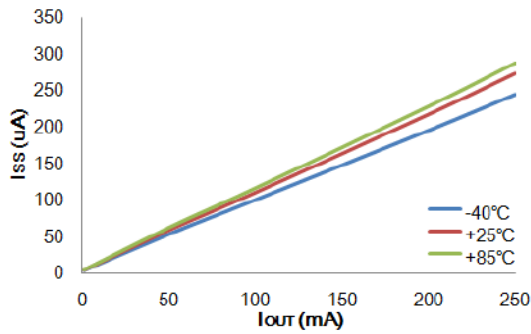

I_{SS} vs I_{OUT} : HT73L09 ($V_{IN}=2.3V$)

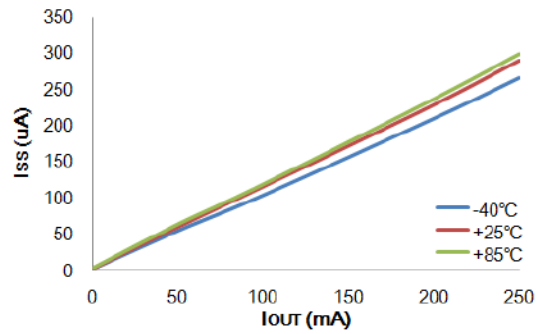

I_{SS} vs I_{OUT} : HT73L10 ($V_{IN}=2.3V$)

Test Condition: $V_{IN}=V_{OUT}+1V$, $V_{CE}=V_{IN}$, $I_{OUT}=10mA$, $C_{IN}=1\mu F$, $C_{OUT}=1\mu F$ and $T_a=25^\circ C$, unless otherwise noted.

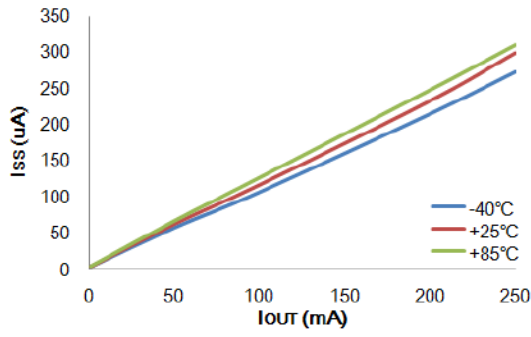

I_{SS} vs I_{OUT} : HT73L12 ($V_{IN}=2.3V$)

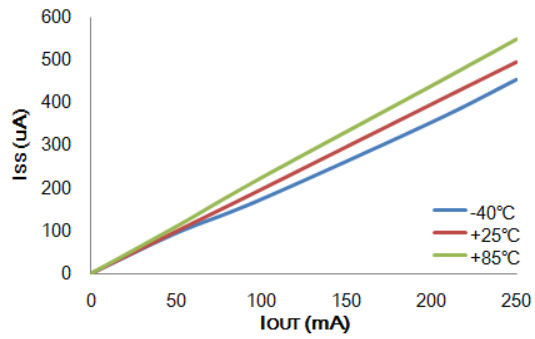

I_{SS} vs I_{OUT} : HT73L15 ($V_{IN}=2.5V$)

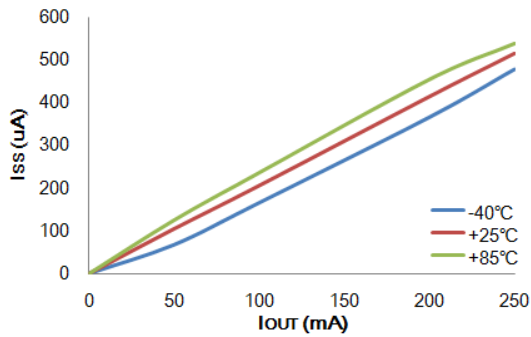

I_{SS} vs I_{OUT} : HT73L18 ($V_{IN}=2.8V$)

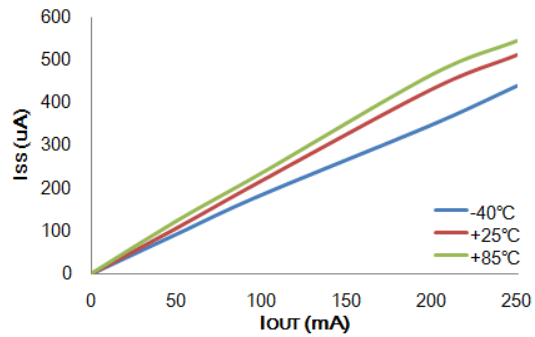

I_{SS} vs I_{OUT} : HT73L25 ($V_{IN}=3.5V$)

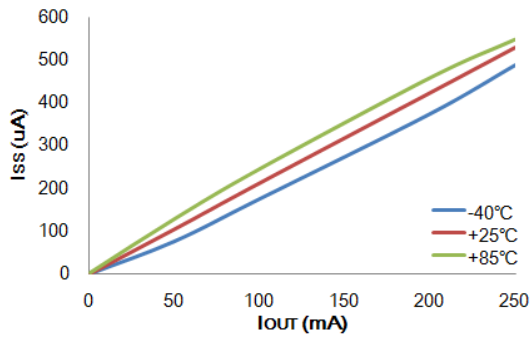

I_{SS} vs I_{OUT} : HT73L27 ($V_{IN}=3.7V$)

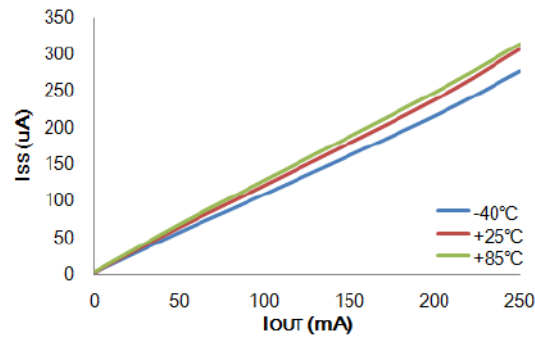

I_{SS} vs I_{OUT} : HT73L30 ($V_{IN}=4.0V$)

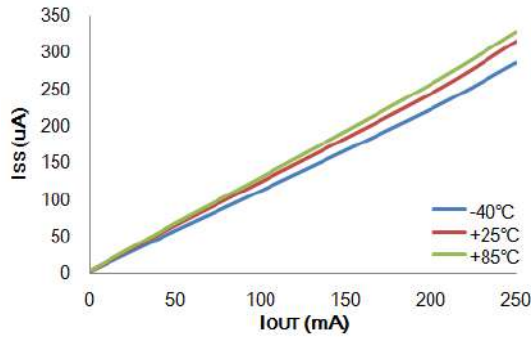

I_{SS} vs I_{OUT} : HT73L33 ($V_{IN}=4.3V$)

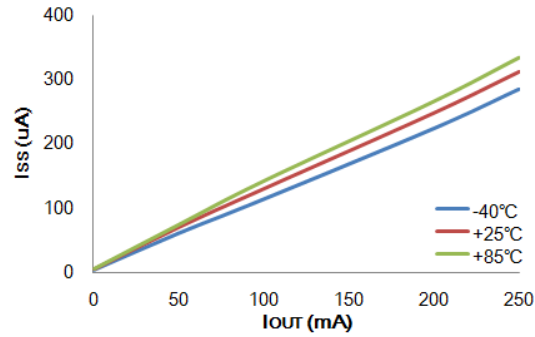

I_{SS} vs I_{OUT} : HT73L36 ($V_{IN}=4.6V$)

Test Condition: $V_{IN}=V_{OUT}+1V$, $V_{CE}=V_{IN}$, $I_{OUT}=10mA$, $C_{IN}=1\mu F$, $C_{OUT}=1\mu F$ and $T_a=25^\circ C$, unless otherwise noted.

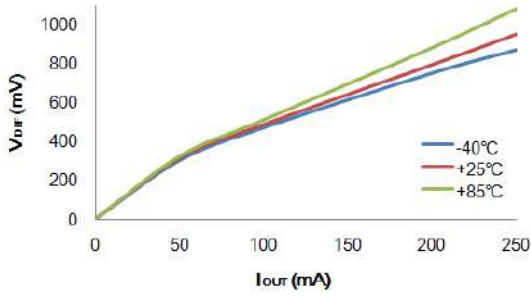

Dropout Voltage: HT73L09

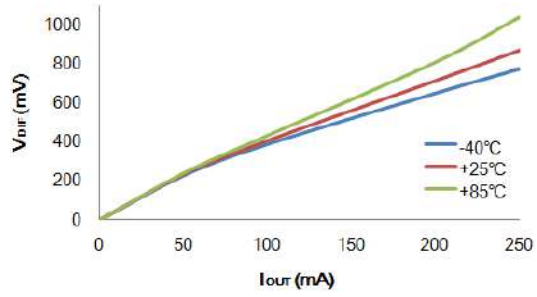

Dropout Voltage: HT73L10

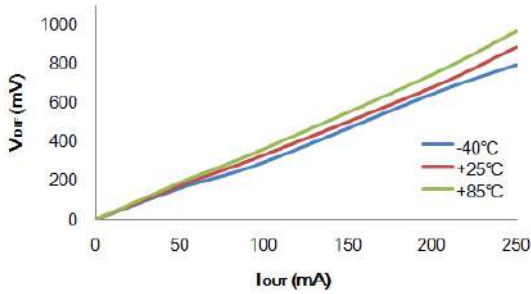

Dropout Voltage: HT73L12

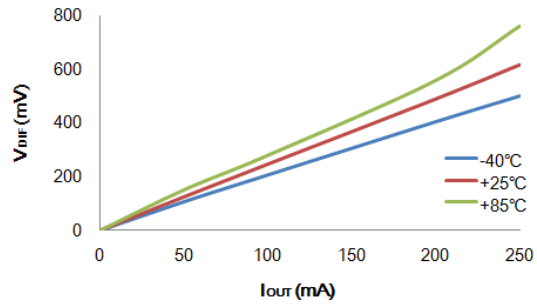

Dropout Voltage: HT73L15

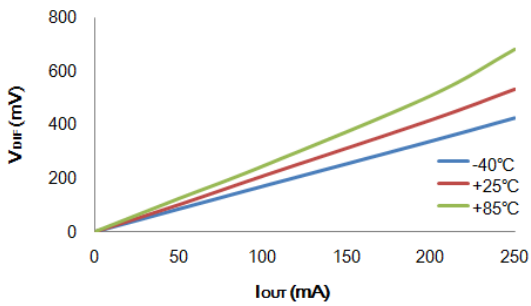

Dropout Voltage: HT73L18

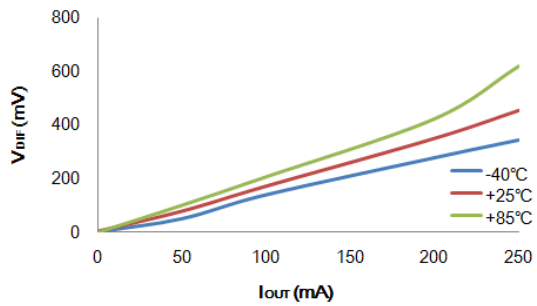

Dropout Voltage: HT73L25

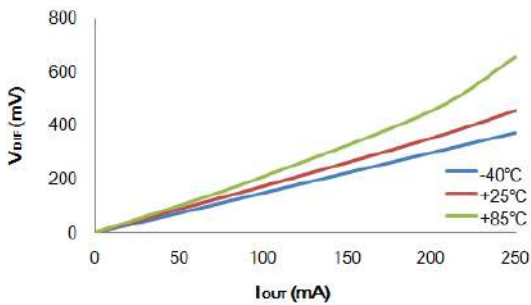

Dropout Voltage: HT73L27

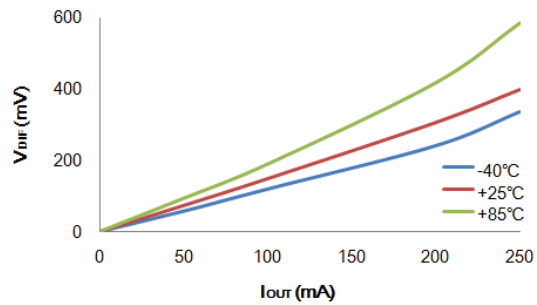

Dropout Voltage: HT73L30

Test Condition: $V_{IN}=V_{OUT}+1V$, $V_{CE}=V_{IN}$, $I_{OUT}=10mA$, $C_{IN}=1\mu F$, $C_{OUT}=1\mu F$ and $T_a=25^\circ C$, unless otherwise noted.

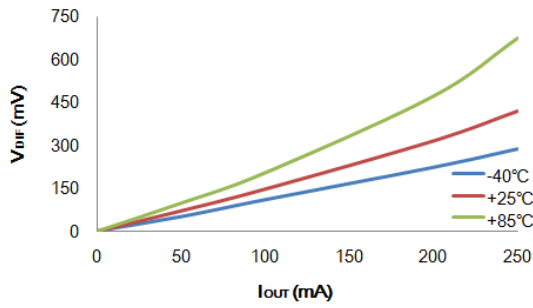

Dropout Voltage: HT73L33

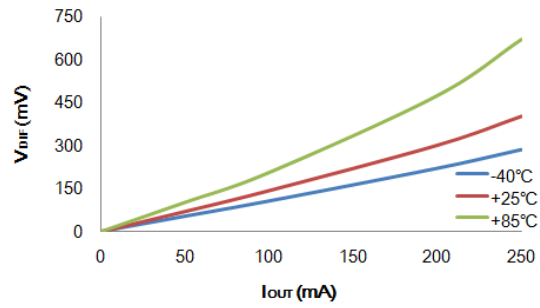

Dropout Voltage: HT73L36

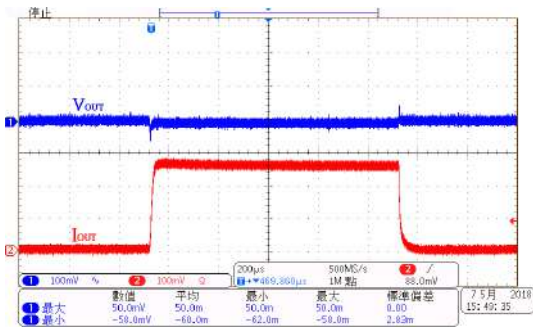

Load Transient Response: HT73L09
($V_{IN}=2.3V$, $I_{OUT}=1mA$ to 250mA)

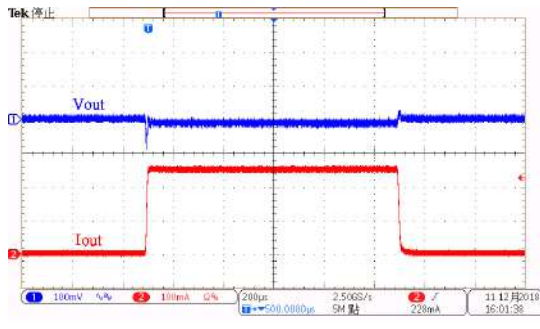

Load Transient Response: HT73L10
($V_{IN}=2.3V$, $I_{OUT}=1mA$ to 250mA)

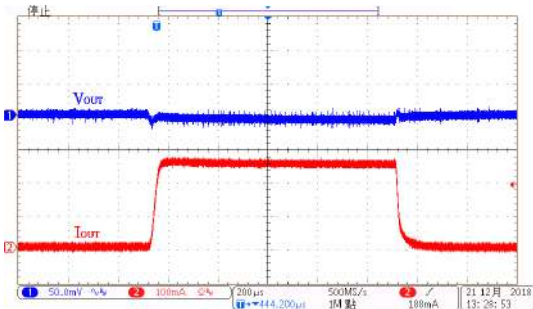

Load Transient Response: HT73L09
($V_{IN}=6.0V$, $I_{OUT}=1mA$ to 250mA)

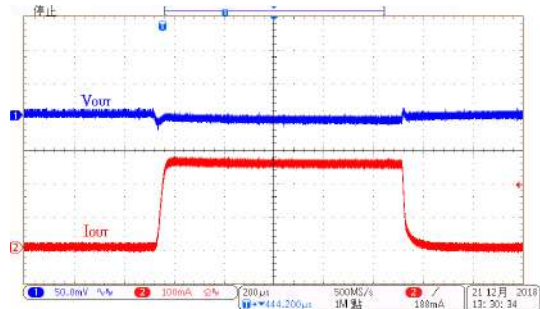

Load Transient Response: HT73L10
($V_{IN}=6.0V$, $I_{OUT}=1mA$ to 250mA)

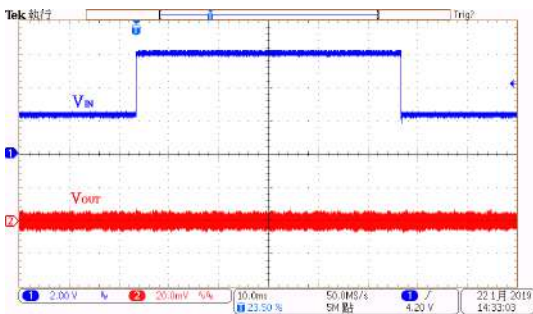

Line Transient Response: HT73L09
($V_{IN}=2.3V$ to 6.0V, $I_{OUT}=10mA$)

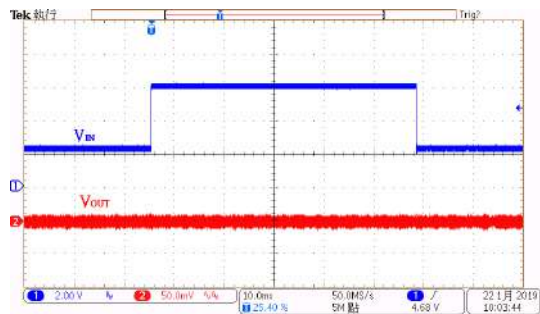

Line Transient Response: HT73L10
($V_{IN}=2.3V$ to 6.0V, $I_{OUT}=10mA$)

Test Condition: $V_{IN}=V_{OUT}+1V$, $V_{CE}=V_{IN}$, $I_{OUT}=10mA$, $C_{IN}=1\mu F$, $C_{OUT}=1\mu F$ and $T_a=25^\circ C$, unless otherwise noted.

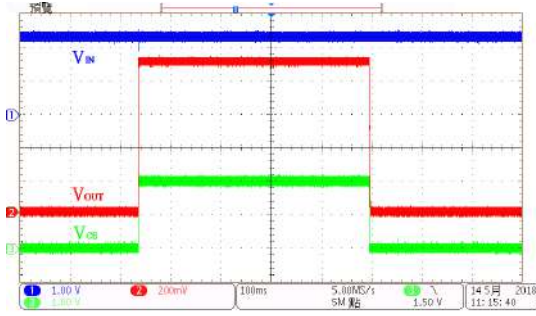

ON/OFF Response: HT73L09
($V_{IN}=2.3V$, $I_{OUT}=0mA$, $V_{CE}=0V$ to $2V$)

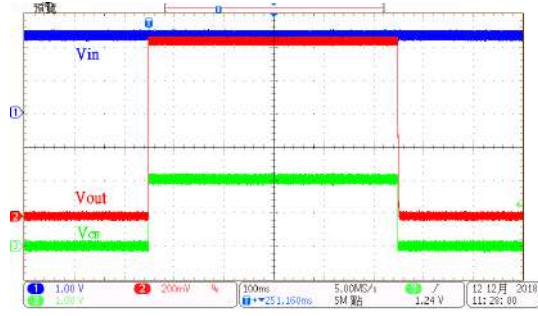

ON/OFF Response: HT73L10
($V_{IN}=2.3V$, $I_{OUT}=0mA$, $V_{CE}=0V$ to $2V$)

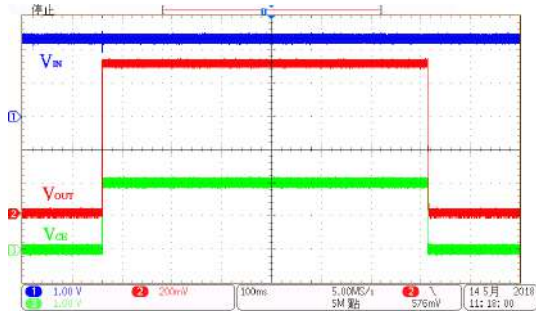

ON/OFF Response: HT73L09
($V_{IN}=2.3V$, $I_{OUT}=200mA$, $V_{CE}=0V$ to $2V$)

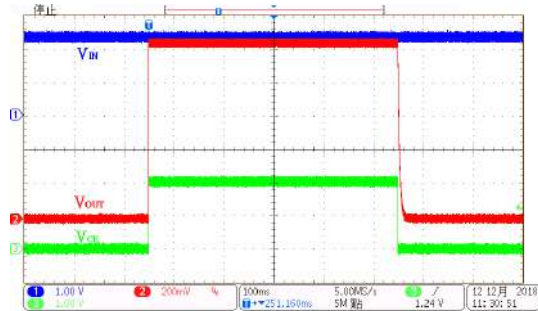

ON/OFF Response: HT73L10
($V_{IN}=2.3V$, $I_{OUT}=200mA$, $V_{CE}=0V$ to $2V$)

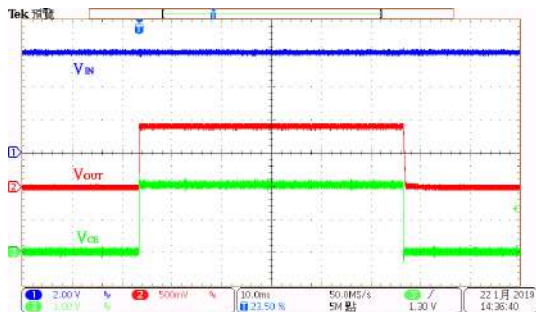

ON/OFF Response: HT73L09
($V_{IN}=6.0V$, $I_{OUT}=0mA$, $V_{CE}=0V$ to $2V$)

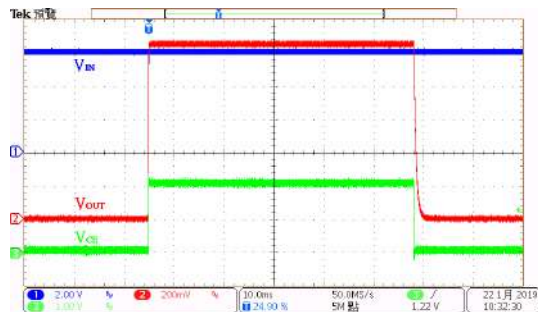

ON/OFF Response: HT73L10
($V_{IN}=6.0V$, $I_{OUT}=0mA$, $V_{CE}=0V$ to $2V$)

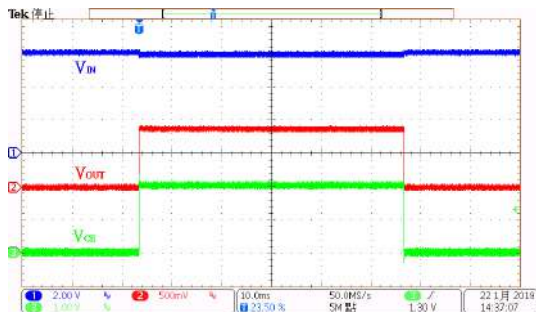

ON/OFF Response: HT73L09
($V_{IN}=6.0V$, $I_{OUT}=200mA$, $V_{CE}=0V$ to $2V$)

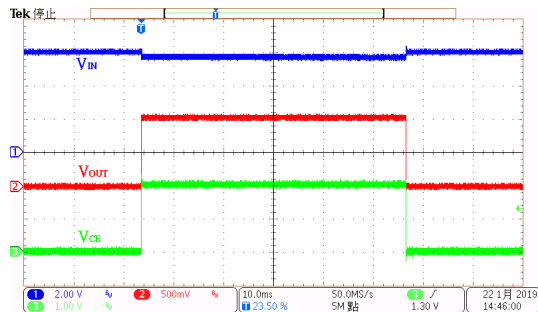

ON/OFF Response: HT73L10
($V_{IN}=6.0V$, $I_{OUT}=200mA$, $V_{CE}=0V$ to $2V$)

Test Condition: $V_{IN}=V_{OUT}+1V$, $V_{CE}=V_{IN}$, $I_{OUT}=10mA$, $C_{IN}=1\mu F$, $C_{OUT}=1\mu F$ and $T_a=25^\circ C$, unless otherwise noted.

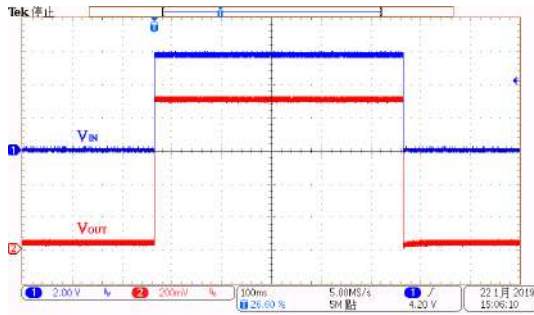

Power On/OFF Response: HT73L09
 $(V_{IN}=6.0V, I_{OUT}=0mA, T_{RISE}=T_{FALL}=0.1ms)$

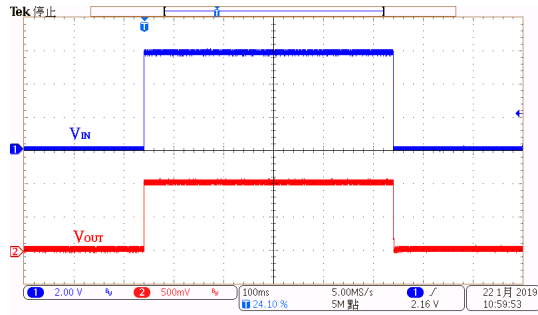

Power On/OFF Response: HT73L10
 $(V_{IN}=6.0V, I_{OUT}=0mA, T_{RISE}=T_{FALL}=0.1ms)$

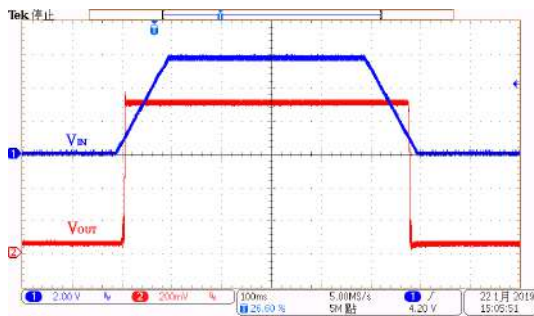

Power On/OFF Response: HT73L09
 $(V_{IN}=6.0V, I_{OUT}=0mA, T_{RISE}=T_{FALL}=100ms)$

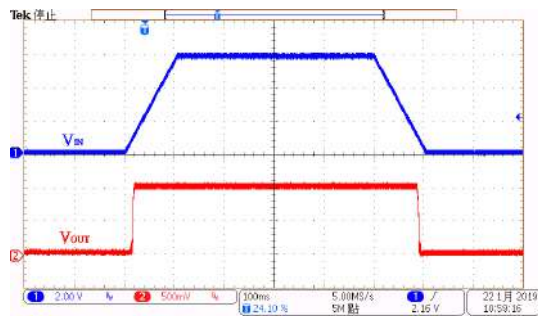

Power On/OFF Response: HT73L10
 $(V_{IN}=6.0V, I_{OUT}=0mA, T_{RISE}=T_{FALL}=100ms)$

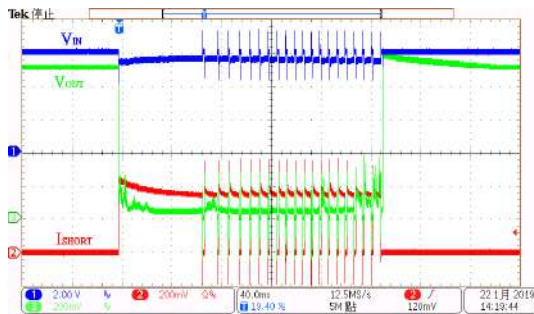

Short Protection: HT73L09
 $(V_{IN}=6.0V, V_{OUT} \text{ Short})$

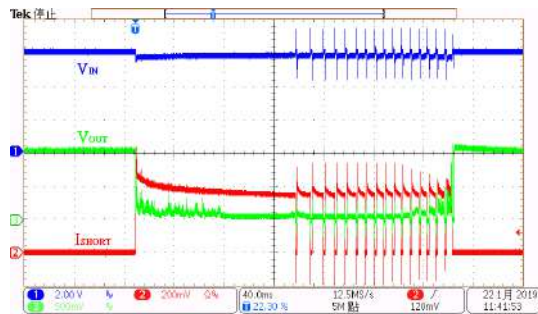

Short Protection: HT73L10
 $(V_{IN}=6.0V, V_{OUT} \text{ Short})$

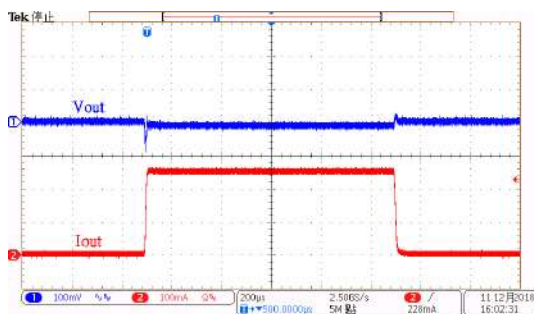

Load Transient Response: HT73L12
 $(V_{IN}=2.3V, I_{OUT}=1mA \text{ to } 250mA)$

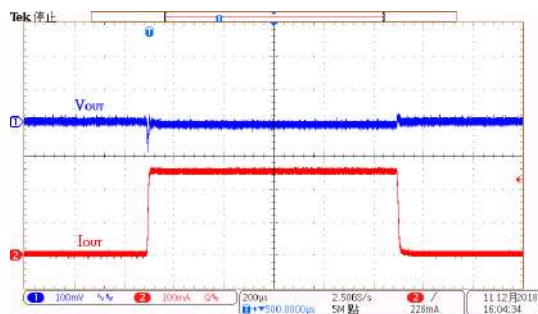

Load Transient Response: HT73L15
 $(V_{IN}=2.5V, I_{OUT}=1mA \text{ to } 250mA)$

Test Condition: $V_{IN}=V_{OUT}+1V$, $V_{CE}=V_{IN}$, $I_{OUT}=10mA$, $C_{IN}=1\mu F$, $C_{OUT}=1\mu F$ and $T_a=25^\circ C$, unless otherwise noted.

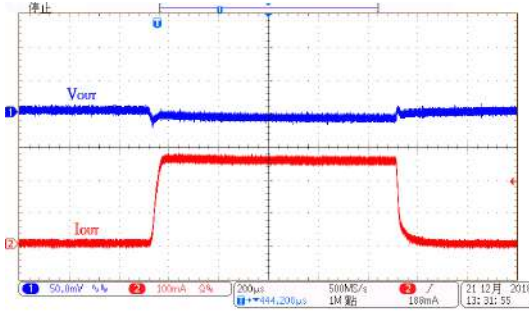

Load Transient Response: HT73L12
($V_{IN}=6.0V$, $I_{OUT}=1mA$ to $250mA$)

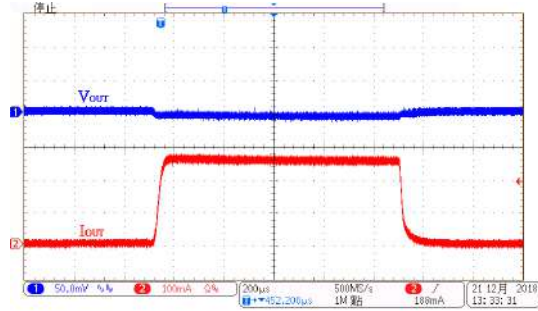

Load Transient Response: HT73L15
($V_{IN}=6.0V$, $I_{OUT}=1mA$ to $250mA$)

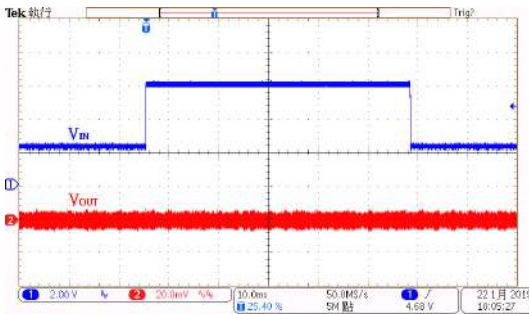

Line Transient Response: HT73L12
($V_{IN}=2.3V$ to $6.0V$, $I_{OUT}=10mA$)

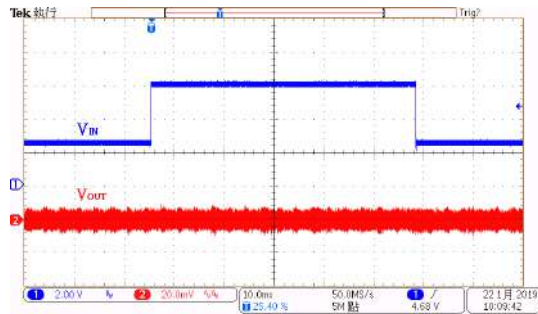

Line Transient Response: HT73L15
($V_{IN}=2.5V$ to $6.0V$, $I_{OUT}=10mA$)

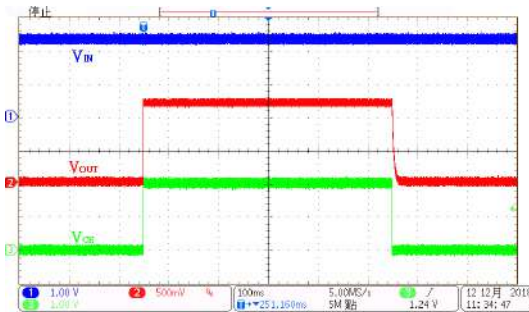

ON/OFF Response: HT73L12
($V_{IN}=2.3V$, $I_{OUT}=0mA$, $V_{CE}=0V$ to $2V$)

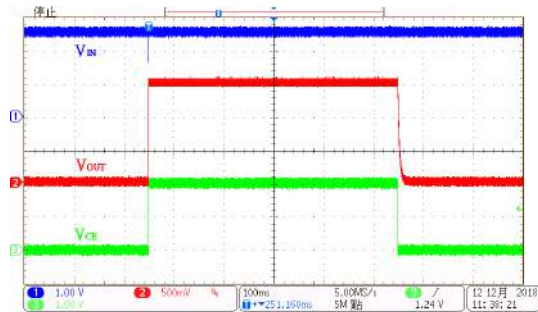

ON/OFF Response: HT73L15
($V_{IN}=2.5V$, $I_{OUT}=0mA$, $V_{CE}=0V$ to $2V$)

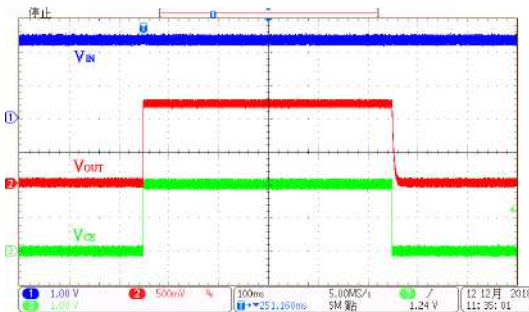

ON/OFF Response: HT73L12
($V_{IN}=2.3V$, $I_{OUT}=200mA$, $V_{CE}=0V$ to $2V$)

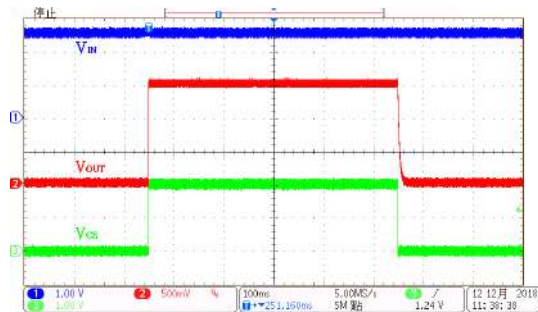

ON/OFF Response: HT73L15
($V_{IN}=2.5V$, $I_{OUT}=200mA$, $V_{CE}=0V$ to $2V$)

Test Condition: $V_{IN}=V_{OUT}+1V$, $V_{CE}=V_{IN}$, $I_{OUT}=10mA$, $C_{IN}=1\mu F$, $C_{OUT}=1\mu F$ and $T_a=25^\circ C$, unless otherwise noted.

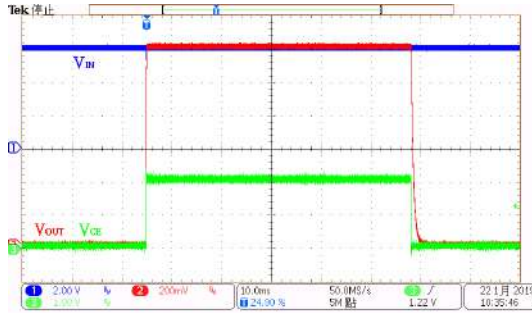

ON/OFF Response: HT73L12
 $(V_{IN}=6.0V, I_{OUT}=0mA, V_{CE}=0V \text{ to } 2V)$

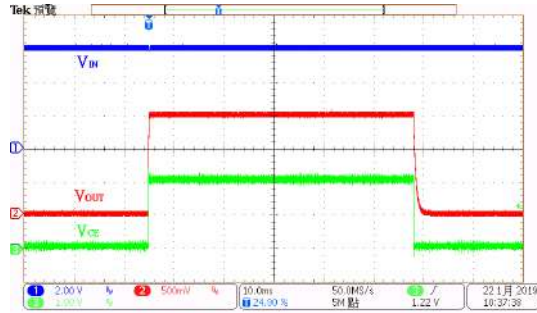

ON/OFF Response: HT73L15
 $(V_{IN}=6.0V, I_{OUT}=0mA, V_{CE}=0V \text{ to } 2V)$

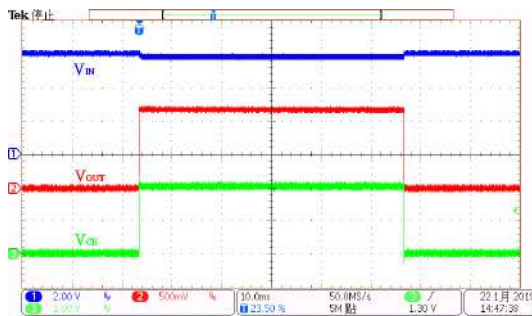

ON/OFF Response: HT73L12
 $(V_{IN}=6.0V, I_{OUT}=200mA, V_{CE}=0V \text{ to } 2V)$

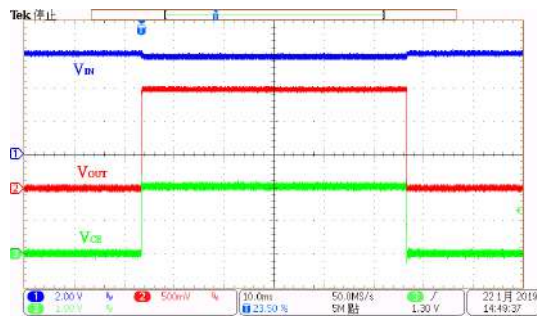

ON/OFF Response: HT73L15
 $(V_{IN}=6.0V, I_{OUT}=200mA, V_{CE}=0V \text{ to } 2V)$

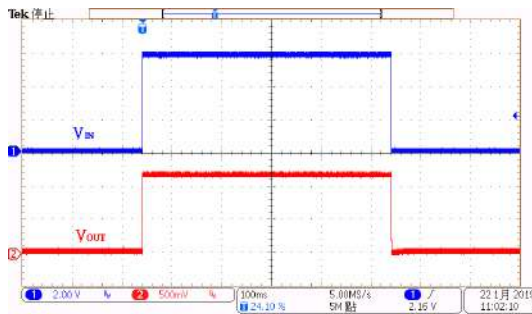

Power On/OFF Response: HT73L12
 $(V_{IN}=6.0V, I_{OUT}=0mA, T_{RISE}=T_{FALL}=0.1ms)$

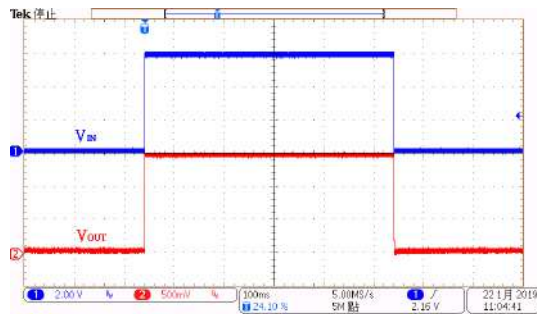

Power On/OFF Response: HT73L15
 $(V_{IN}=6.0V, I_{OUT}=0mA, T_{RISE}=T_{FALL}=0.1ms)$

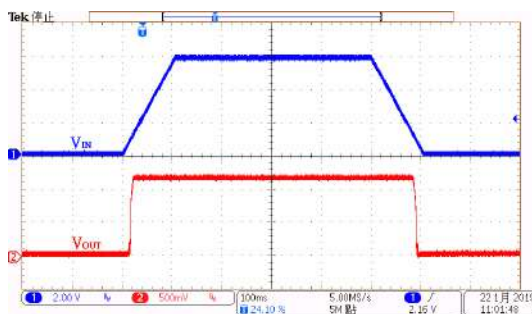

Power On/OFF Response: HT73L12
 $(V_{IN}=6.0V, I_{OUT}=0mA, T_{RISE}=T_{FALL}=100ms)$

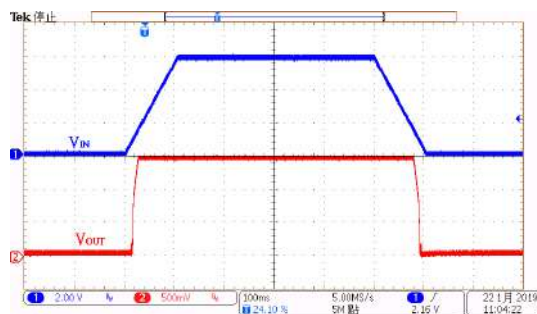

Power On/OFF Response: HT73L15
 $(V_{IN}=6.0V, I_{OUT}=0mA, T_{RISE}=T_{FALL}=100ms)$

Test Condition: $V_{IN}=V_{OUT}+1V$, $V_{CE}=V_{IN}$, $I_{OUT}=10mA$, $C_{IN}=1\mu F$, $C_{OUT}=1\mu F$ and $T_a=25^\circ C$, unless otherwise noted.

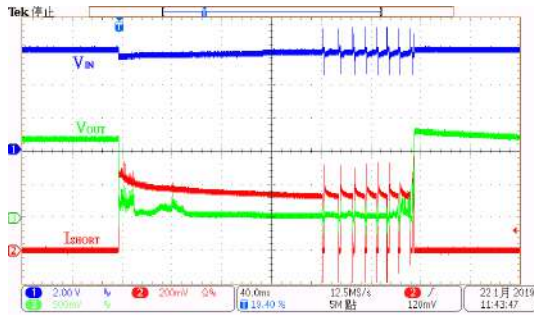

Short Protection: HT73L12
($V_{IN}=6.0V$, V_{OUT} Short)

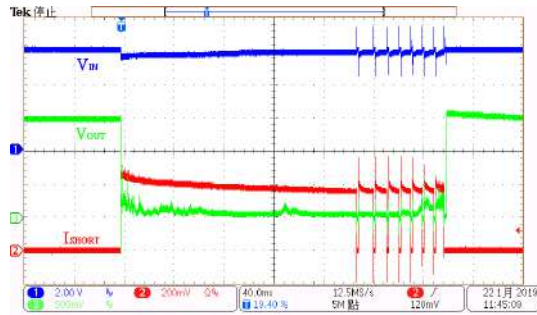

Short Protection: HT73L15
($V_{IN}=6.0V$, V_{OUT} Short)

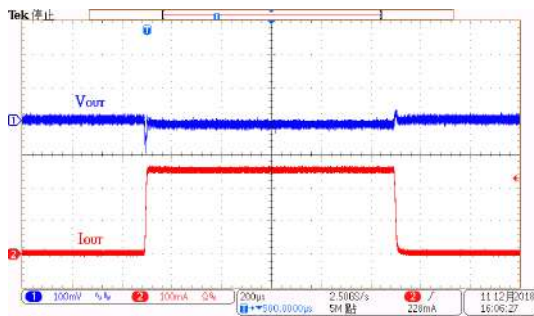

Load Transient Response: HT73L18
($V_{IN}=2.8V$, $I_{OUT}=1mA$ to $250mA$)

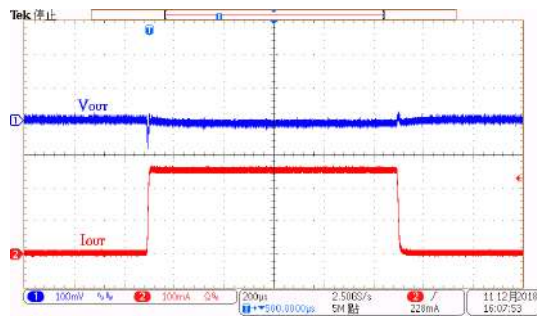

Load Transient Response: HT73L25
($V_{IN}=3.5V$, $I_{OUT}=1mA$ to $250mA$)

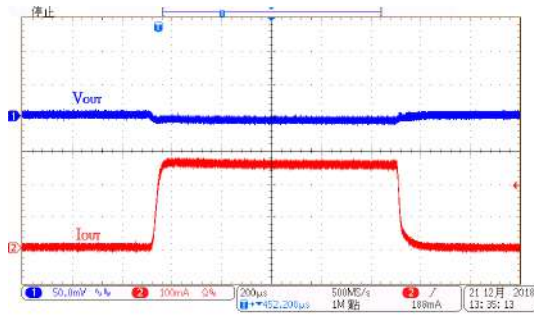

Load Transient Response: HT73L18
($V_{IN}=6.0V$, $I_{OUT}=1mA$ to $250mA$)

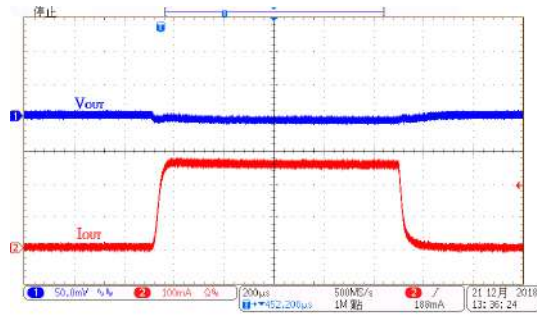

Load Transient Response: HT73L25
($V_{IN}=6.0V$, $I_{OUT}=1mA$ to $250mA$)

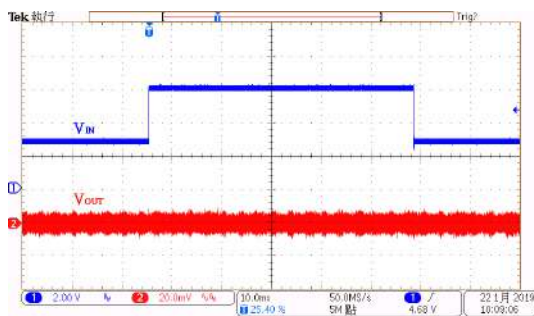

Line Transient Response: HT73L18
($V_{IN}=2.8V$ to $6.0V$, $I_{OUT}=10mA$)

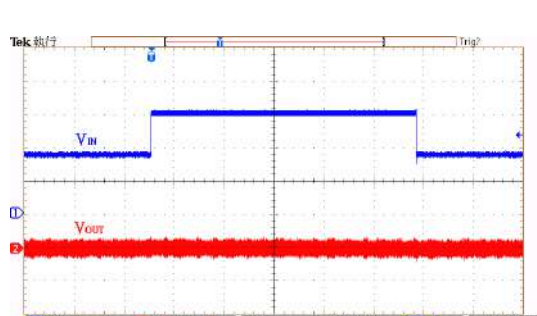

Line Transient Response: HT73L25
($V_{IN}=3.5V$ to $6.0V$, $I_{OUT}=10mA$)

Test Condition: $V_{IN}=V_{OUT}+1V$, $V_{CE}=V_{IN}$, $I_{OUT}=10mA$, $C_{IN}=1\mu F$, $C_{OUT}=1\mu F$ and $T_a=25^\circ C$, unless otherwise noted.

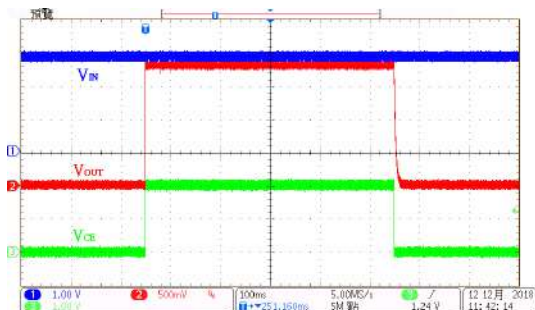

ON/OFF Response: HT73L18
($V_{IN}=2.8V$, $I_{OUT}=0mA$, $V_{CE}=0V$ to $2V$)

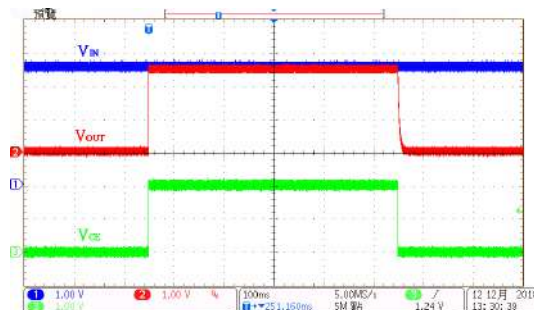

ON/OFF Response: HT73L25
($V_{IN}=3.5V$, $I_{OUT}=0mA$, $V_{CE}=0V$ to $2V$)

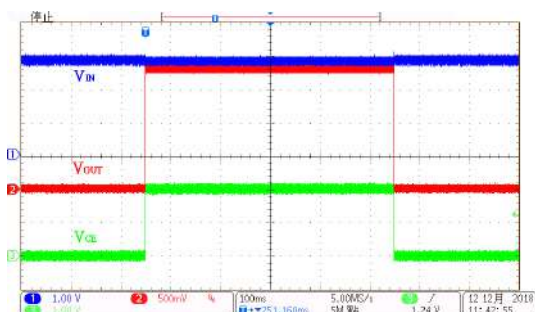

ON/OFF Response: HT73L18
($V_{IN}=2.8V$, $I_{OUT}=200mA$, $V_{CE}=0V$ to $2V$)

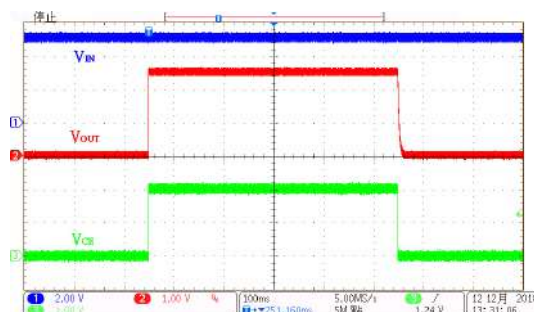

ON/OFF Response: HT73L25
($V_{IN}=3.5V$, $I_{OUT}=200mA$, $V_{CE}=0V$ to $2V$)

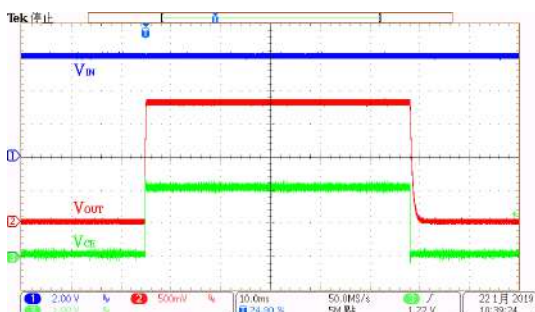

ON/OFF Response: HT73L18
($V_{IN}=6.0V$, $I_{OUT}=0mA$, $V_{CE}=0V$ to $2V$)

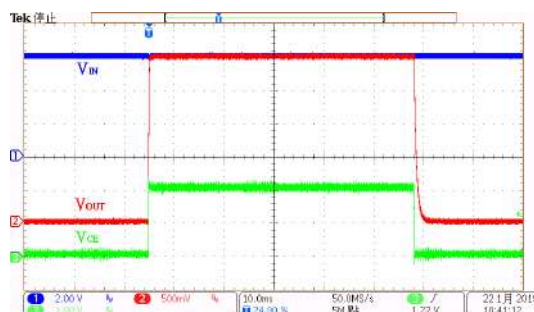

ON/OFF Response: HT73L25
($V_{IN}=6.0V$, $I_{OUT}=0mA$, $V_{CE}=0V$ to $2V$)

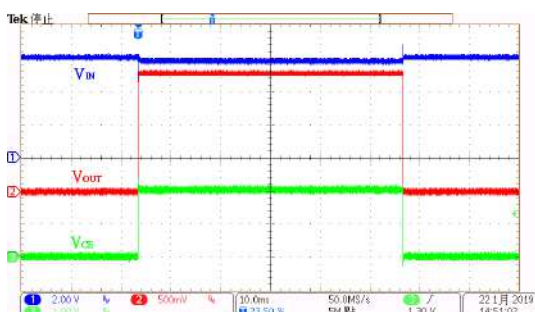

ON/OFF Response: HT73L18
($V_{IN}=6.0V$, $I_{OUT}=200mA$, $V_{CE}=0V$ to $2V$)

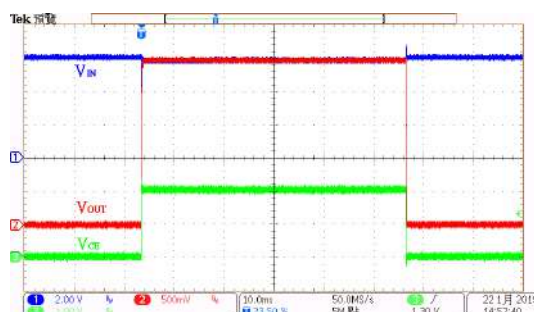

ON/OFF Response: HT73L25
($V_{IN}=6.0V$, $I_{OUT}=200mA$, $V_{CE}=0V$ to $2V$)

Test Condition: $V_{IN}=V_{OUT}+1V$, $V_{CE}=V_{IN}$, $I_{OUT}=10mA$, $C_{IN}=1\mu F$, $C_{OUT}=1\mu F$ and $T_a=25^\circ C$, unless otherwise noted.

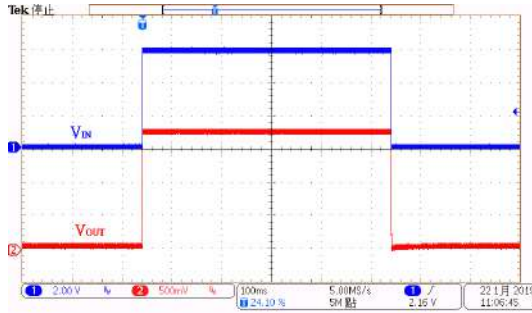

Power On/OFF Response: HT73L18
($V_{IN}=6.0V$, $I_{OUT}=0mA$, $T_{RISE}=T_{FALL}=0.1ms$)

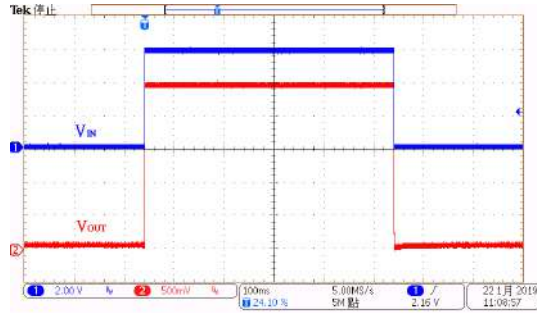

Power On/OFF Response: HT73L25
($V_{IN}=6.0V$, $I_{OUT}=0mA$, $T_{RISE}=T_{FALL}=0.1ms$)

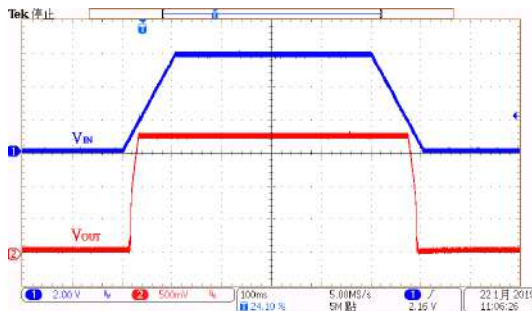

Power On/OFF Response: HT73L18
($V_{IN}=6.0V$, $I_{OUT}=0mA$, $T_{RISE}=T_{FALL}=100ms$)

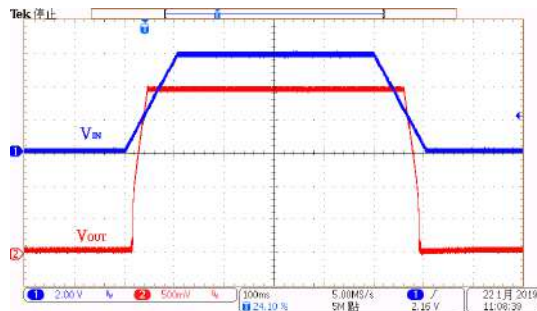

Power On/OFF Response: HT73L25
($V_{IN}=6.0V$, $I_{OUT}=0mA$, $T_{RISE}=T_{FALL}=100ms$)

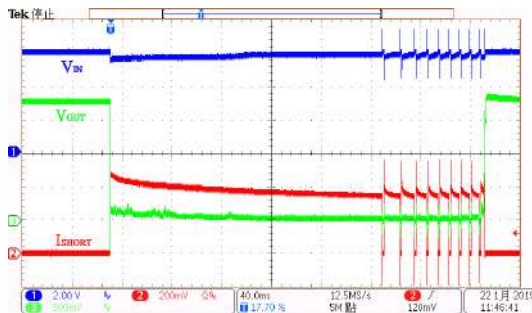

Short Protection: HT73L18
($V_{IN}=6.0V$, V_{OUT} Short)

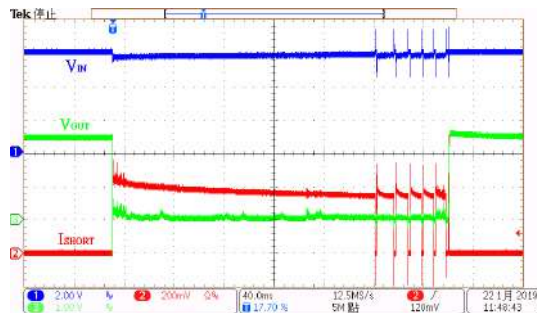

Short Protection: HT73L25
($V_{IN}=6.0V$, V_{OUT} Short)

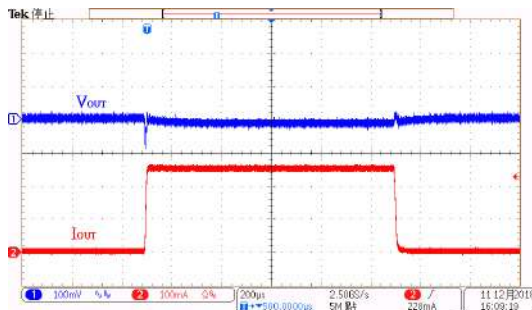

Load Transient Response: HT73L27
($V_{IN}=3.7V$, $I_{OUT}=1mA$ to $250mA$)

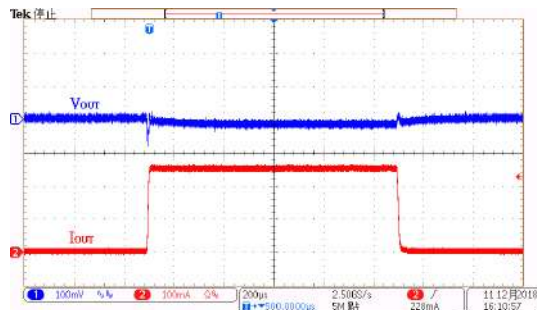

Load Transient Response: HT73L30
($V_{IN}=4.0V$, $I_{OUT}=1mA$ to $250mA$)

Test Condition: $V_{IN}=V_{OUT}+1V$, $V_{CE}=V_{IN}$, $I_{OUT}=10mA$, $C_{IN}=1\mu F$, $C_{OUT}=1\mu F$ and $T_a=25^\circ C$, unless otherwise noted.

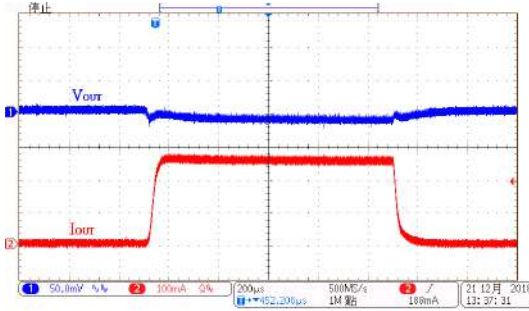

Load Transient Response: HT73L27
($V_{IN}=6.0V$, $I_{OUT}=1mA$ to $250mA$)

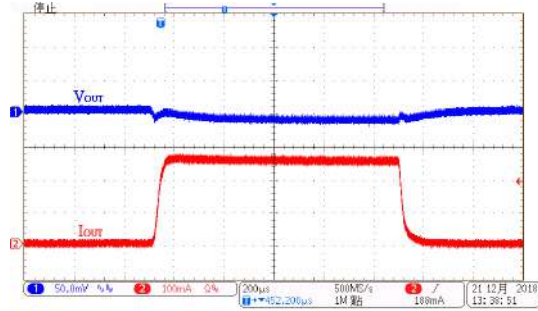

Load Transient Response: HT73L30
($V_{IN}=6.0V$, $I_{OUT}=1mA$ to $250mA$)

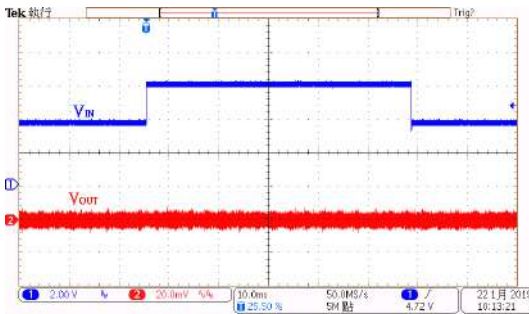

Line Transient Response: HT73L27
($V_{IN}=3.7V$ to $6.0V$, $I_{OUT}=10mA$)

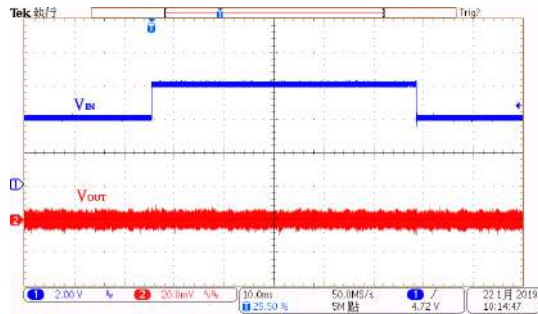

Line Transient Response: HT73L30
($V_{IN}=3.5V$ to $6.0V$, $I_{OUT}=10mA$)

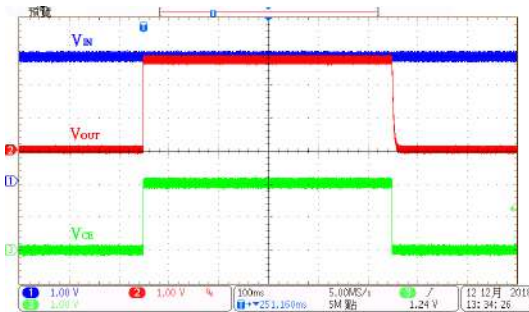

ON/OFF Response: HT73L27
($V_{IN}=3.7V$, $I_{OUT}=0mA$, $V_{CE}=0V$ to $2V$)

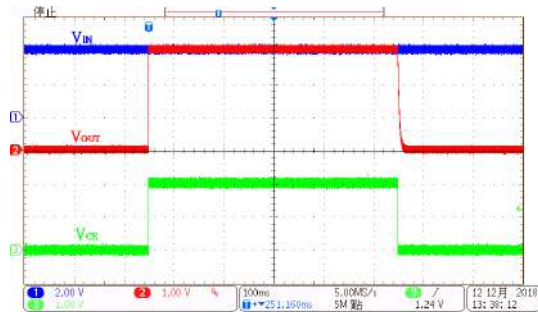

ON/OFF Response: HT73L30
($V_{IN}=4.0V$, $I_{OUT}=0mA$, $V_{CE}=0V$ to $2V$)

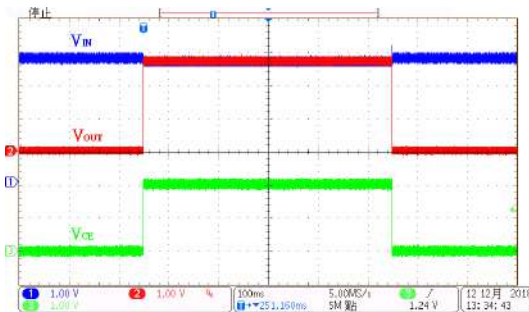

ON/OFF Response: HT73L27
($V_{IN}=3.7V$, $I_{OUT}=200mA$, $V_{CE}=0V$ to $2V$)

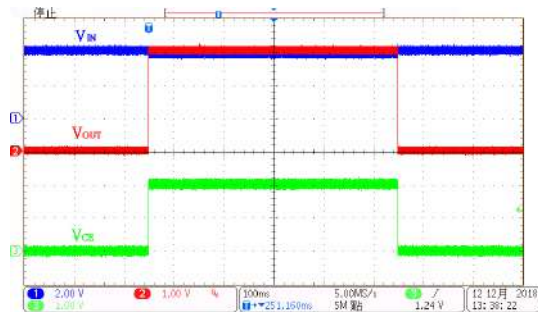

ON/OFF Response: HT73L30
($V_{IN}=4.0V$, $I_{OUT}=200mA$, $V_{CE}=0V$ to $2V$)

Test Condition: $V_{IN}=V_{OUT}+1V$, $V_{CE}=V_{IN}$, $I_{OUT}=10mA$, $C_{IN}=1\mu F$, $C_{OUT}=1\mu F$ and $T_a=25^\circ C$, unless otherwise noted.

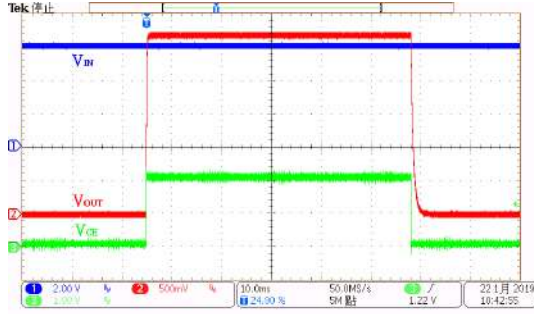

ON/OFF Response: HT73L27
 $(V_{IN}=6.0V, I_{OUT}=0mA, V_{CE}=0V \text{ to } 2V)$

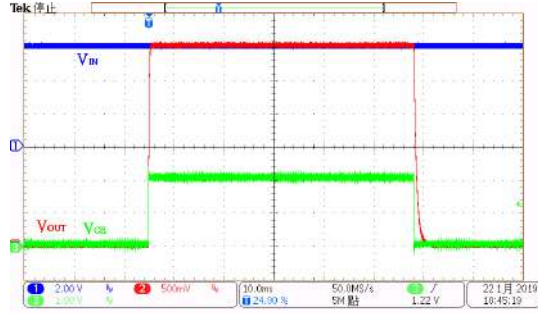

ON/OFF Response: HT73L30
 $(V_{IN}=6.0V, I_{OUT}=0mA, V_{CE}=0V \text{ to } 2V)$

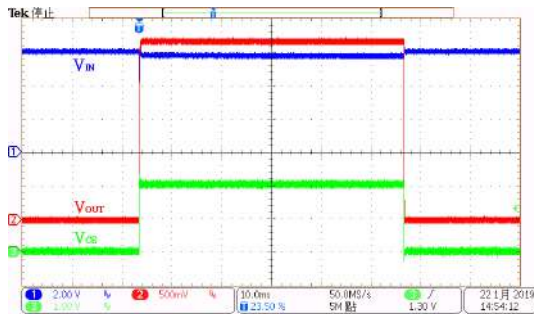

ON/OFF Response: HT73L27
 $(V_{IN}=6.0V, I_{OUT}=200mA, V_{CE}=0V \text{ to } 2V)$

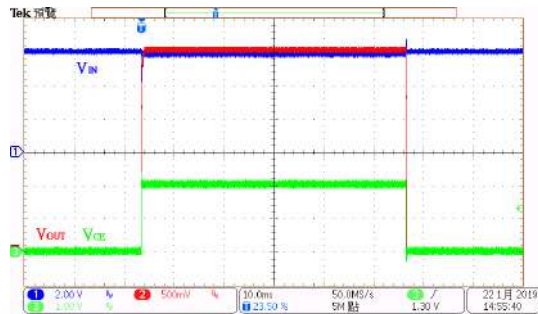

ON/OFF Response: HT73L30
 $(V_{IN}=6.0V, I_{OUT}=200mA, V_{CE}=0V \text{ to } 2V)$

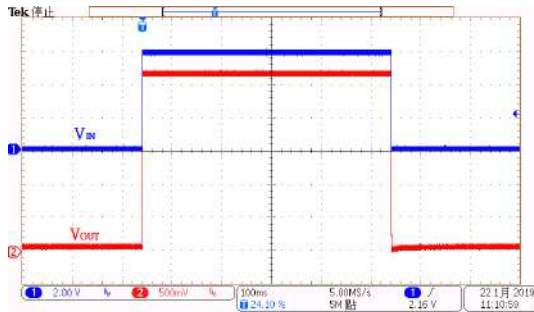

Power On/OFF Response: HT73L27
 $(V_{IN}=6.0V, I_{OUT}=0mA, T_{RISE}=T_{FALL}=0.1ms)$

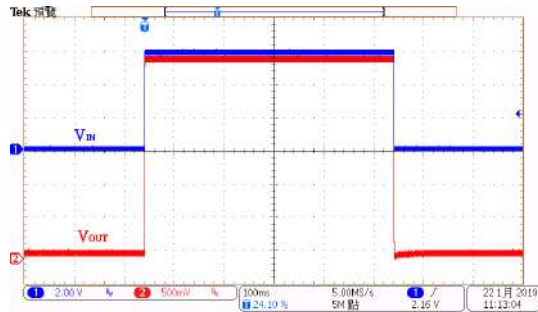

Power On/OFF Response: HT73L30
 $(V_{IN}=6.0V, I_{OUT}=0mA, T_{RISE}=T_{FALL}=0.1ms)$

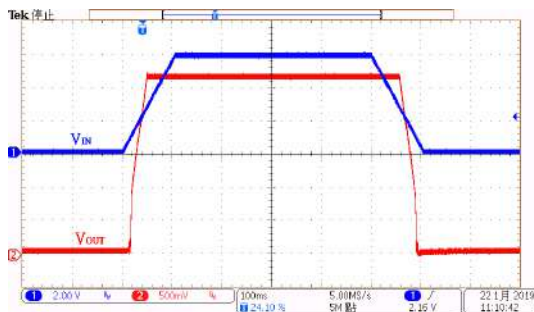

Power On/OFF Response: HT73L27
 $(V_{IN}=6.0V, I_{OUT}=0mA, T_{RISE}=T_{FALL}=100ms)$

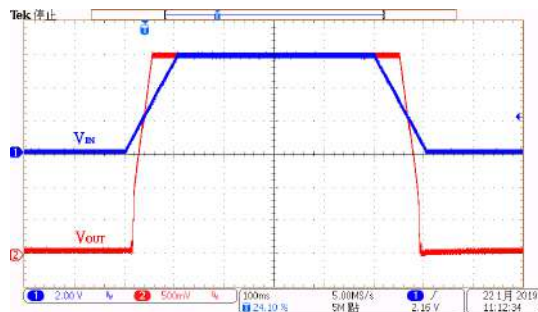

Power On/OFF Response: HT73L30
 $(V_{IN}=6.0V, I_{OUT}=0mA, T_{RISE}=T_{FALL}=100ms)$

Test Condition: $V_{IN}=V_{OUT}+1V$, $V_{CE}=V_{IN}$, $I_{OUT}=10mA$, $C_{IN}=1\mu F$, $C_{OUT}=1\mu F$ and $T_a=25^\circ C$, unless otherwise noted.

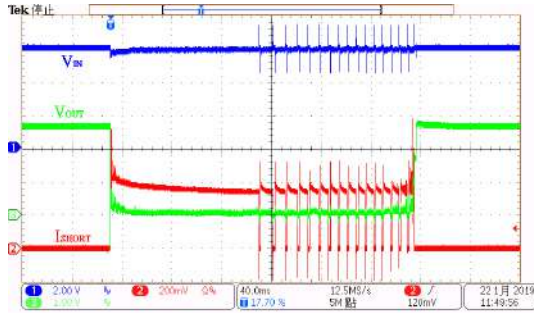

Short protection: HT73L27
($V_{IN}=6.0V$, V_{OUT} short)

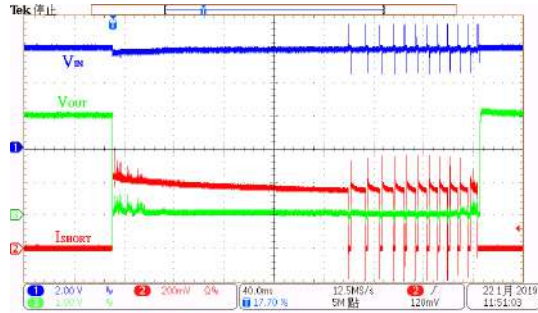

Short protection: HT73L30
($V_{IN}=6.0V$, V_{OUT} short)

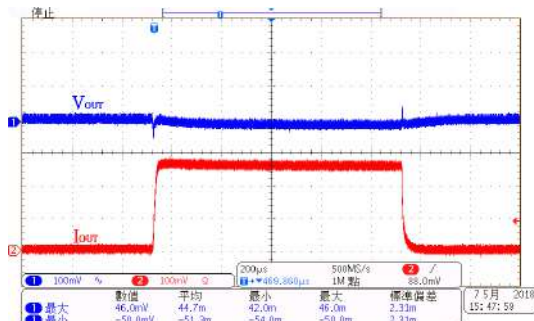

Load Transient Response: HT73L33
($V_{IN}=4.3V$, $I_{OUT}=1mA$ to $250mA$)

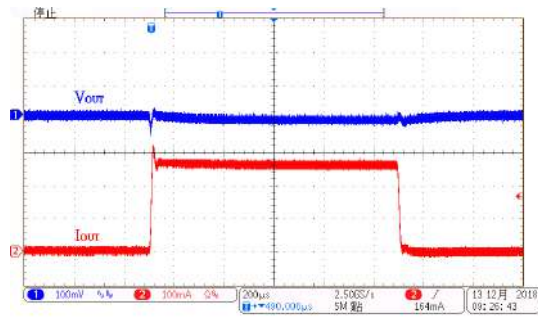

Load Transient Response: HT73L36
($V_{IN}=4.6V$, $I_{OUT}=1mA$ to $250mA$)

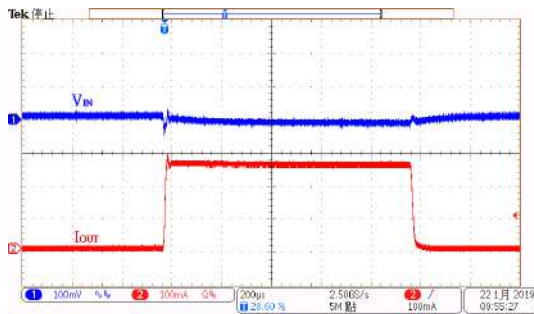

Load Transient Response: HT73L33
($V_{IN}=6.0V$, $I_{OUT}=1mA$ to $250mA$)

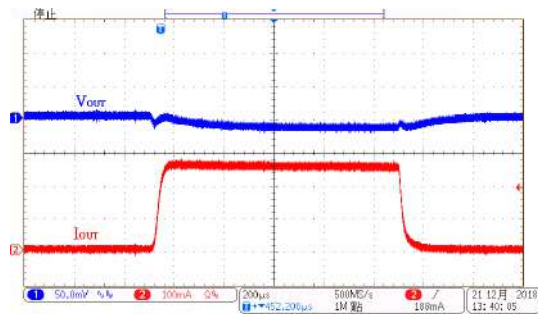

Load Transient Response: HT73L36
($V_{IN}=6.0V$, $I_{OUT}=1mA$ to $250mA$)

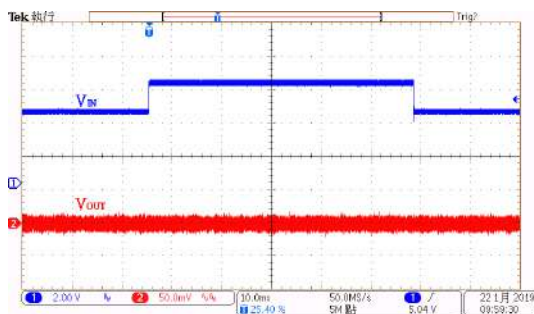

Line Transient Response: HT73L33
($V_{IN}=4.3V$ to $6.0V$, $I_{OUT}=10mA$)

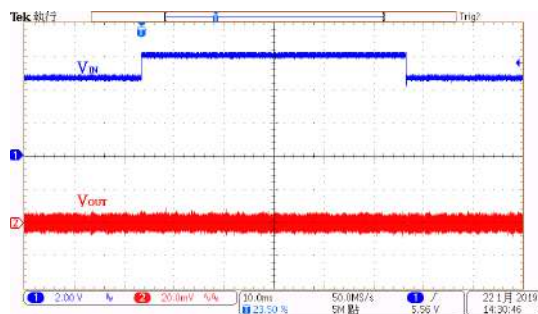

Line Transient Response: HT73L36
($V_{IN}=4.6$ to $6.0V$, $I_{OUT}=10mA$)

Test Condition: $V_{IN}=V_{OUT}+1V$, $V_{CE}=V_{IN}$, $I_{OUT}=10mA$, $C_{IN}=1\mu F$, $C_{OUT}=1\mu F$ and $T_a=25^\circ C$, unless otherwise noted.

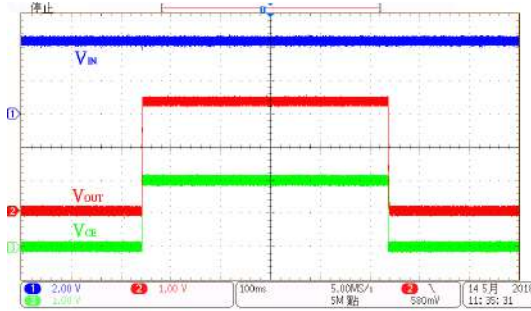

ON/OFF Response: HT73L33
($V_{IN}=4.3V$, $I_{OUT}=0mA$, $V_{CE}=0V$ to $2V$)

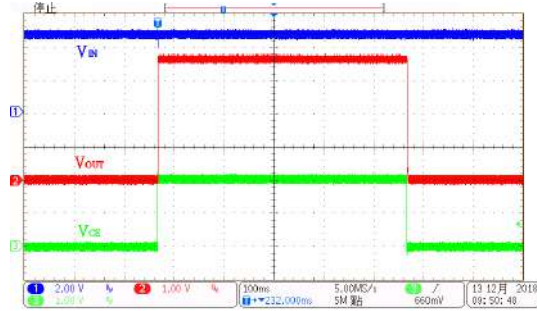

ON/OFF Response: HT73L36
($V_{IN}=4.6V$, $I_{OUT}=0mA$, $V_{CE}=0V$ to $2V$)

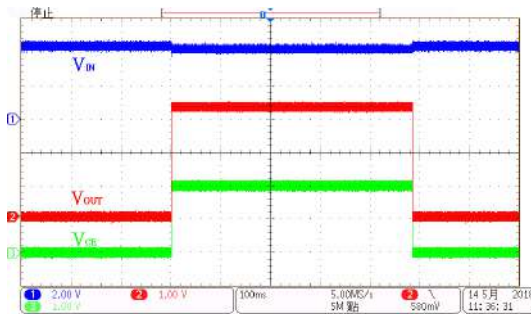

ON/OFF Response: HT73L33
($V_{IN}=4.3V$, $I_{OUT}=200mA$, $V_{CE}=0V$ to $2V$)

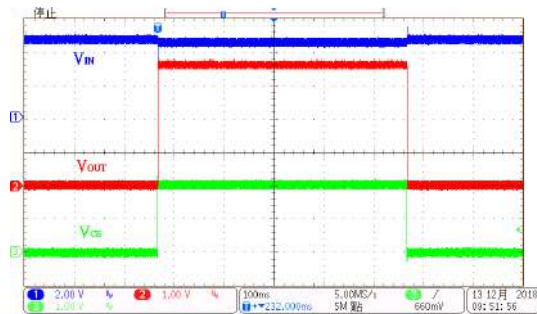

ON/OFF Response: HT73L36
($V_{IN}=4.6V$, $I_{OUT}=200mA$, $V_{CE}=0V$ to $2V$)

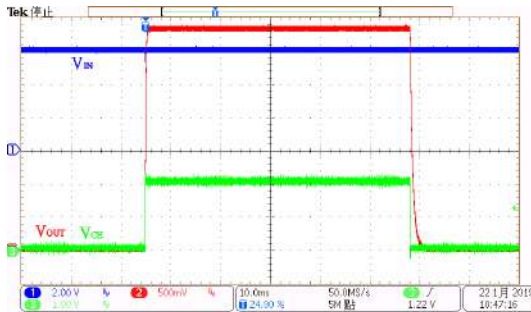

ON/OFF Response: HT73L33
($V_{IN}=6.0V$, $I_{OUT}=0mA$, $V_{CE}=0V$ to $2V$)

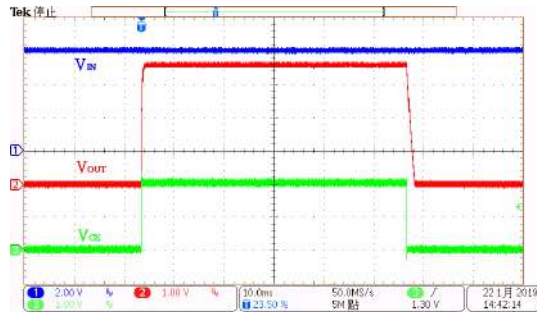

ON/OFF Response: HT73L36
($V_{IN}=6.0V$, $I_{OUT}=0mA$, $V_{CE}=0V$ to $2V$)

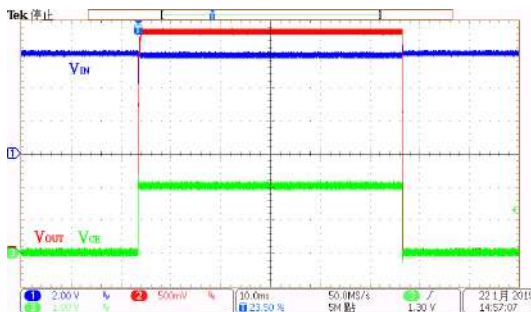

ON/OFF Response: HT73L33
($V_{IN}=6.0V$, $I_{OUT}=200mA$, $V_{CE}=0V$ to $2V$)

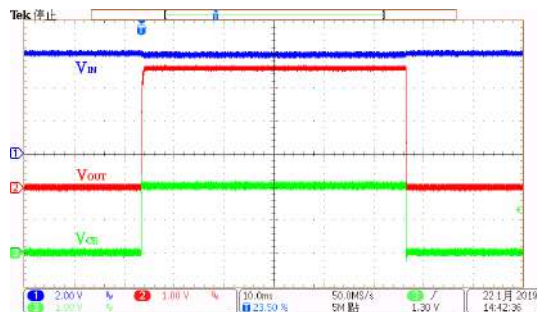

ON/OFF Response: HT73L36
($V_{IN}=6.0V$, $I_{OUT}=200mA$, $V_{CE}=0V$ to $2V$)

Test Condition: $V_{IN}=V_{OUT}+1V$, $V_{CE}=V_{IN}$, $I_{OUT}=10mA$, $C_{IN}=1\mu F$, $C_{OUT}=1\mu F$ and $T_a=25^\circ C$, unless otherwise noted.

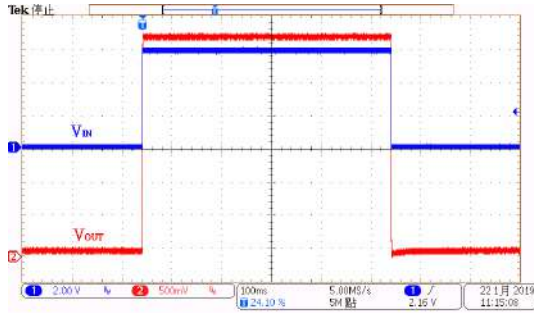

Power On/OFF Response: HT73L33
 ($V_{IN}=6.0V$, $I_{OUT}=0mA$, $T_{RISE}=T_{FALL}=0.1ms$)

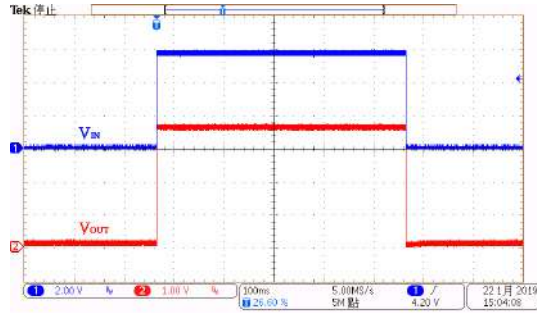

Power On/OFF Response: HT73L36
 ($V_{IN}=6.0V$, $I_{OUT}=0mA$, $T_{RISE}=T_{FALL}=0.1ms$)

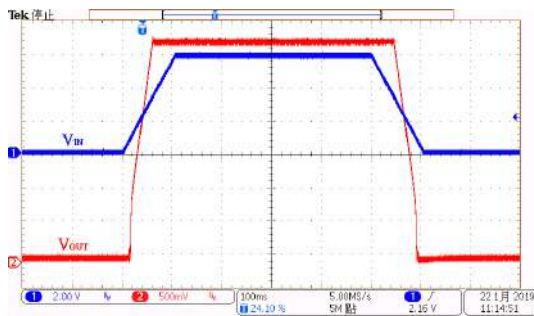

Power On/OFF Response: HT73L33
 ($V_{IN}=6.0V$, $I_{OUT}=0mA$, $T_{RISE}=T_{FALL}=100ms$)

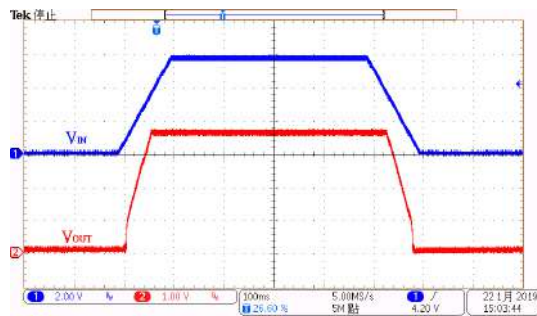

Power On/OFF Response: HT73L36
 ($V_{IN}=6.0V$, $I_{OUT}=0mA$, $T_{RISE}=T_{FALL}=100ms$)

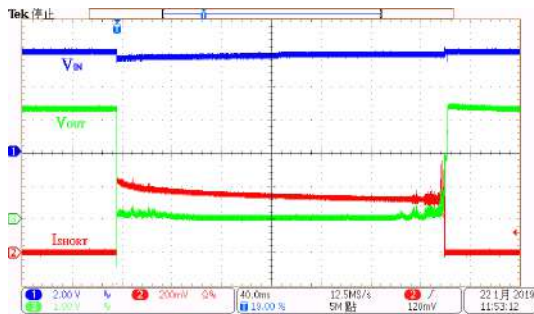

Short Protection: HT73L33
 ($V_{IN}=6.0V$, V_{OUT} Short)

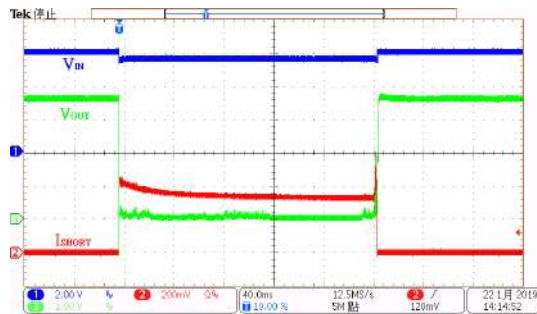

Short Protection: HT73L36
 ($V_{IN}=6.0V$, V_{OUT} Short)

Test Condition: $V_{IN}=V_{OUT}+1V$, $V_{CE}=V_{IN}$, $I_{OUT}=10mA$, $C_{IN}=1\mu F$, $C_{OUT}=1\mu F$ and $T_a=25^\circ C$, unless otherwise noted.

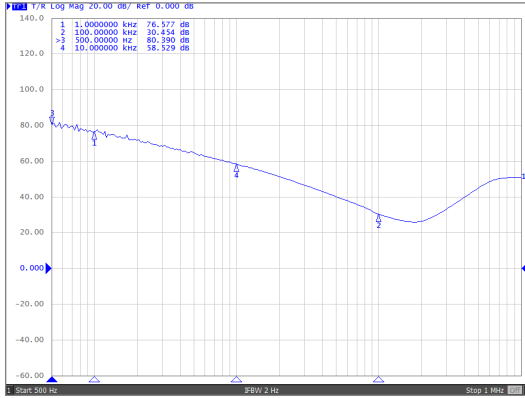

PSRR: HT73L09
($V_{IN}=6.0V$, $I_{OUT}=50mA$, $f=1kHz@76.5dB$)

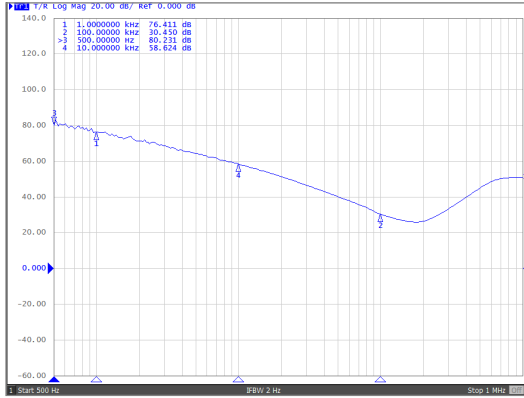

PSRR: HT73L10
($V_{IN}=6.0V$, $I_{OUT}=50mA$, $f=1kHz@76.4dB$)

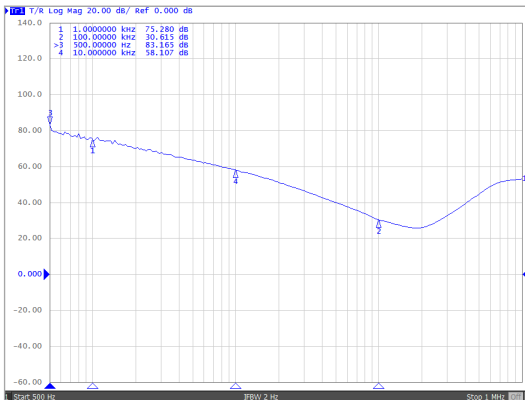

PSRR: HT73L12
($V_{IN}=6.0V$, $I_{OUT}=50mA$, $f=1kHz@75.2dB$)

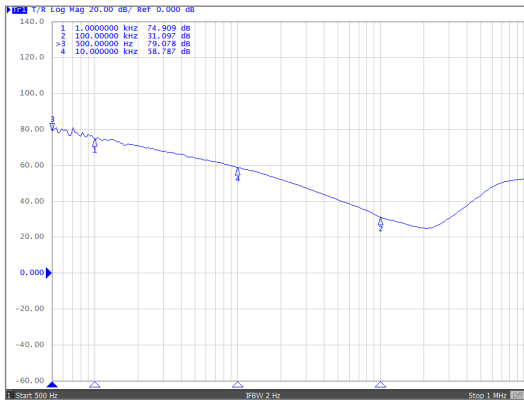

PSRR: HT73L15
($V_{IN}=6.0V$, $I_{OUT}=50mA$, $f=1kHz@74.9dB$)

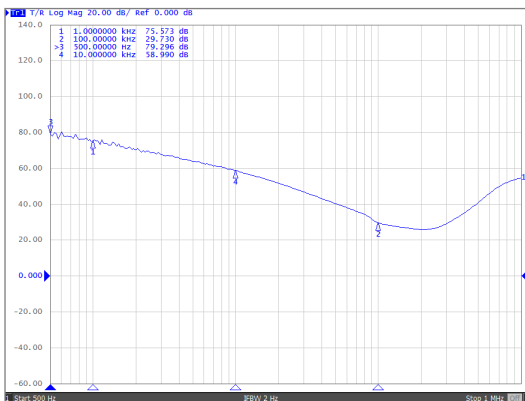

PSRR: HT73L18
($V_{IN}=6.0V$, $I_{OUT}=50mA$, $f=1kHz@75.5dB$)

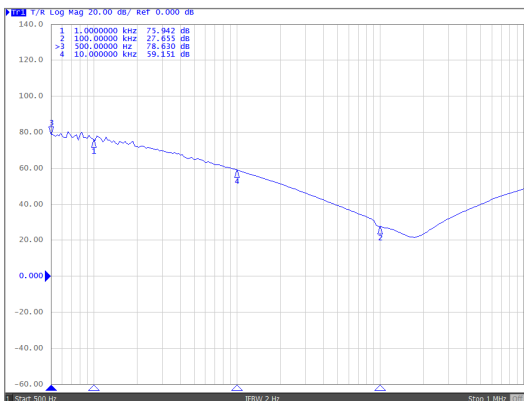

PSRR: HT73L25
($V_{IN}=6.0V$, $I_{OUT}=50mA$, $f=1kHz@75.9dB$)

Test Condition: $V_{IN}=V_{OUT}+1V$, $V_{CE}=V_{IN}$, $I_{OUT}=10mA$, $C_{IN}=1\mu F$, $C_{OUT}=1\mu F$ and $T_a=25^\circ C$, unless otherwise noted.

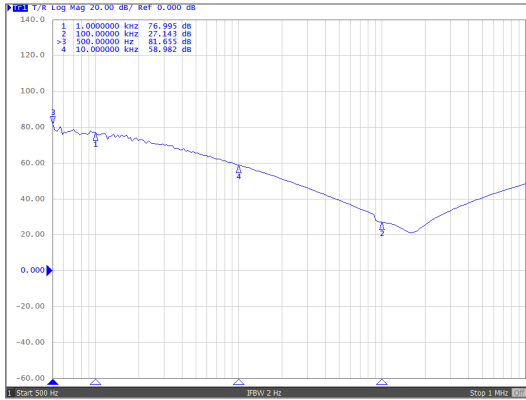

PSRR: HT73L27
($V_{IN}=6.0V$, $I_{OUT}=50mA$, $f=1kHz@76.9dB$)

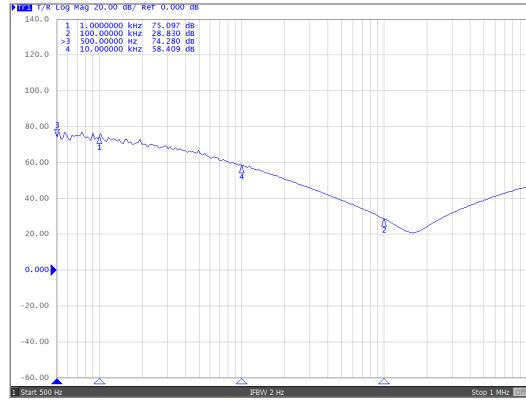

PSRR: HT73L30
($V_{IN}=6.0V$, $I_{OUT}=50mA$, $f=1kHz@75dB$)

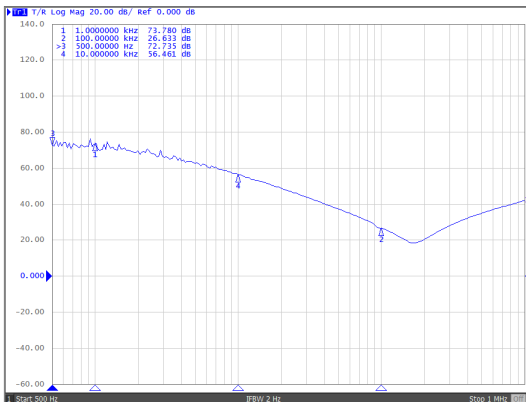

PSRR: HT73L33
($V_{IN}=6.0V$, $I_{OUT}=50mA$, $f=1kHz@73.7dB$)

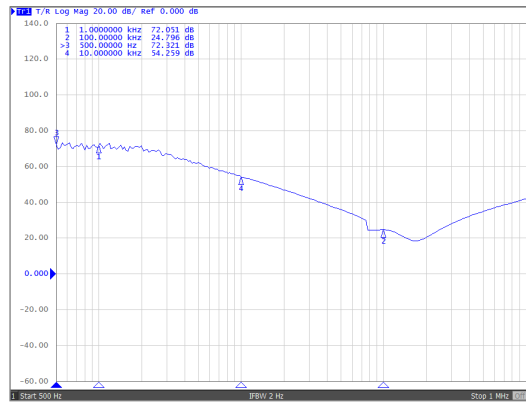

PSRR: HT73L36
($V_{IN}=6.0V$, $I_{OUT}=50mA$, $f=1kHz@72dB$)

Application Information

When using the HT73Lxx regulators it is important that the following application points are noted to ensure correct operation.

OCP and OTP Protection Features

The HT73Lxx devices include over current protection and junction over temperature protection to prevent IC damage even if the output is shorted to ground. If the output is shorted to ground, the output current will be clamped to 300mA which will cause the junction temperature to rise. Once the junction temperature exceeds 150°C, the device power section will be shut down to prevent thermal damage. When the junction temperature falls to 125°C the protection function will be switched off and the device will resume normal operation.

Fast Output Discharge Function

When the CE pin is low the output voltage will be discharged rapidly to 0V via an internal 500Ω resistor. This discharge path will not appear when the OCP or OTP protection functions are active.

Input Capacitor C_{IN} Considerations

It is suggested that a value of at least 1μF is chosen for the input capacitor. A ceramic type is recommended as they have better temperature coefficients and due to their lower ESR – Equivalent Series Resistance.

Output Capacitor C_{OUT} Considerations

The output capacitor plays an important role in keeping the output voltage stable. For ceramic types, an output capacitance value of at least 1μF should be chosen. For E-cap types, a capacitance value of at least 2.2μF should be chosen.

Thermal Considerations

The maximum power dissipation depends on the thermal resistance of the package, the PCB layout, the rate of the surrounding airflow and the difference

between the junction and ambient temperature. The maximum power dissipation can be calculated using the following formula:

$$P_{D(MAX)} = (T_{J(MAX)} - T_a) / \theta_{JA}$$

where $T_{J(MAX)}$ is the maximum junction temperature, T_a is the ambient temperature and θ_{JA} is the junction-to-ambient thermal resistance of the IC package in degrees per watt. The following table shows the θ_{JA} values for various package types.

Package Type	θ_{JA} (°C/W)
4DFN	250 °C/W
SOT23-5	500 °C/W
SOT89	200 °C/W

For maximum operating rating conditions, the maximum junction temperature is 150°C. However, it is recommended that the maximum junction temperature does not exceed 125°C during normal operation to maintain an adequate margin for device reliability. The derating curves of different packages for maximum power dissipation are as follows:

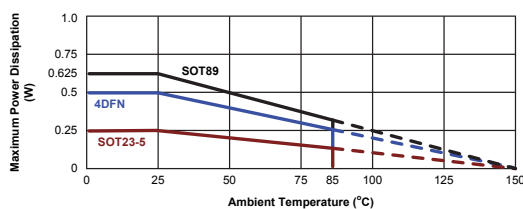

Power Dissipation Calculation

In order to keep the device within its operating limits and to maintain a regulated output voltage, the power dissipation of the device, given by P_D , must not exceed the Maximum Power Dissipation, given by $P_{D(MAX)}$. Therefore $P_D \leq P_{D(MAX)}$. From the diagram it can be seen that almost all of this power is generated across the pass transistor which is acting like a variable resistor in series with the load to keep the output voltage constant. This generated power which will appear as heat, must never allow the device to exceed its maximum junction temperature.

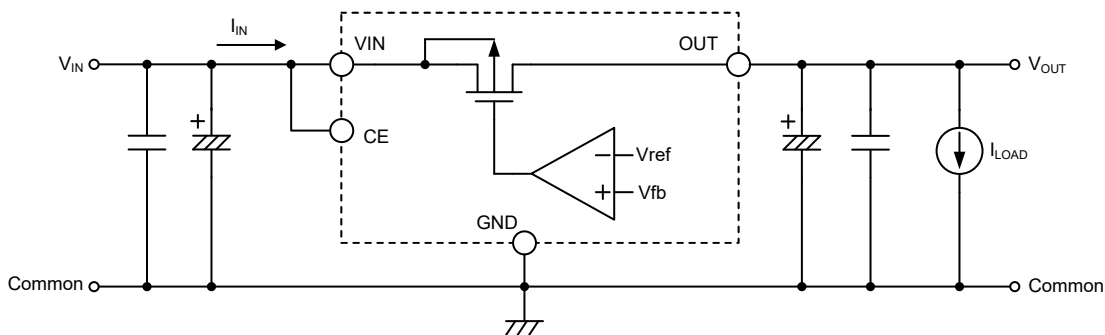

In practical applications the regulator may be called upon to provide both steady state and transient currents due to the transient nature of the load. Although the device may be working well within its limits with its steady state current, care must be taken with transient loads which may cause the current to rise close to its maximum current value. Care must be taken with transient loads and currents as this will result in device junction temperature rises which must not exceed the maximum junction temperature. With both steady state and transient currents, the important current to consider is the average or more precisely the RMS current which is the value of current that will appear as heat generated in the device. The following diagram shows how the average current relates to the transient currents.

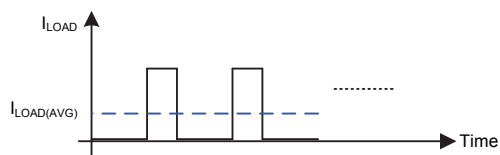

As the quiescent current of the device is very small it can generally be ignored and as a result the input current can be assumed to be equal to the output current. Therefore the power dissipation of the device, P_D , can be calculated as the voltage drop across the input and output multiplied by the current, given by the equation, $P_D = (V_{IN} - V_{OUT}) \times I_{IN}$. As the input current is also equal to the load current the power dissipation $P_D = (V_{IN} - V_{OUT}) \times I_{LOAD}$. However, with transient load currents, $P_D = (V_{IN} - V_{OUT}) \times I_{LOAD(AVG)}$ as shown in the figure.

Application Circuits

With Enable Pin Control

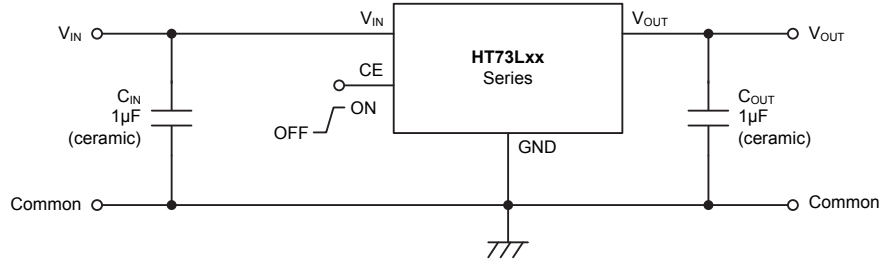

Without Enable Pin Control

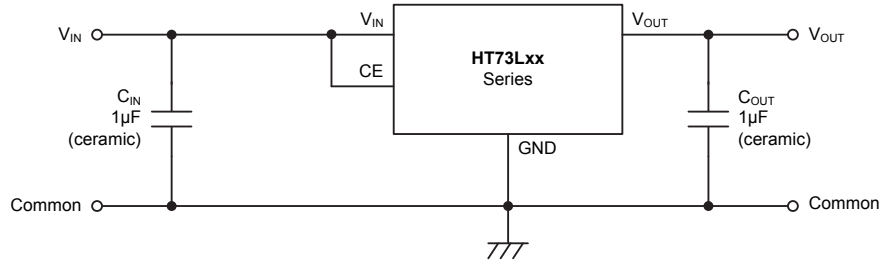

Package Information

Note that the package information provided here is for consultation purposes only. As this information may be updated at regular intervals users are reminded to consult the [Holtek website](#) for the latest version of the [Package/ Carton Information](#).

Additional supplementary information with regard to packaging is listed below. Click on the relevant section to be transferred to the relevant website page.

- [Package Information \(include Outline Dimensions, Product Tape and Reel Specifications\)](#)
- [The Operation Instruction of Packing Materials](#)
- [Carton information](#)

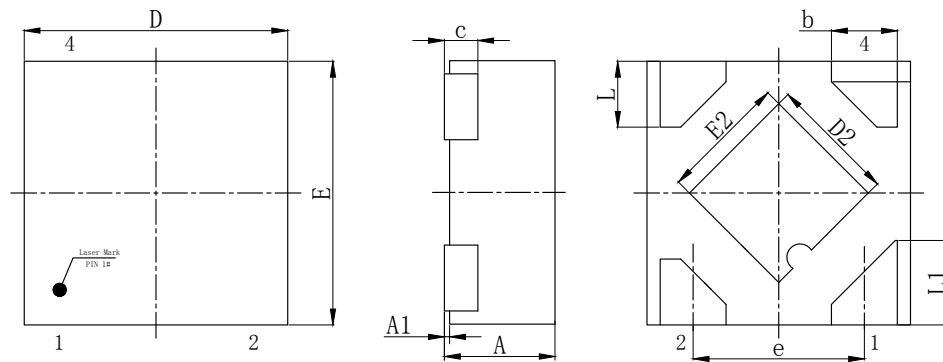
4-pin DFN (1mm×1mm×0.4mm) Outline Dimensions

Symbol	Dimensions in inch		
	Min.	Nom.	Max.
A	0.014	—	0.016
A1	0.000	0.001	0.002
A3	—	—	—
b	0.008	0.010	0.012
D	0.037	0.039	0.041
E	0.037	0.039	0.041
e	—	0.026 BSC	—
D2	0.015	0.019	0.023
E2	0.015	0.019	0.023
L	0.008	0.010	0.012
L1	0.011	0.013	0.015
K	—	—	—

Symbol	Dimensions in mm		
	Min.	Nom.	Max.
A	0.35	—	0.40
A1	0.00	0.02	0.05
A3	—	—	—
b	0.20	0.25	0.30
D	0.95	1.00	1.05
E	0.95	1.00	1.05
e	—	0.65 BSC	—
D2	0.38	0.48	0.58
E2	0.38	0.48	0.58
L	0.20	0.25	0.30
K	—	—	—

5-pin SOT23 Outline Dimensions

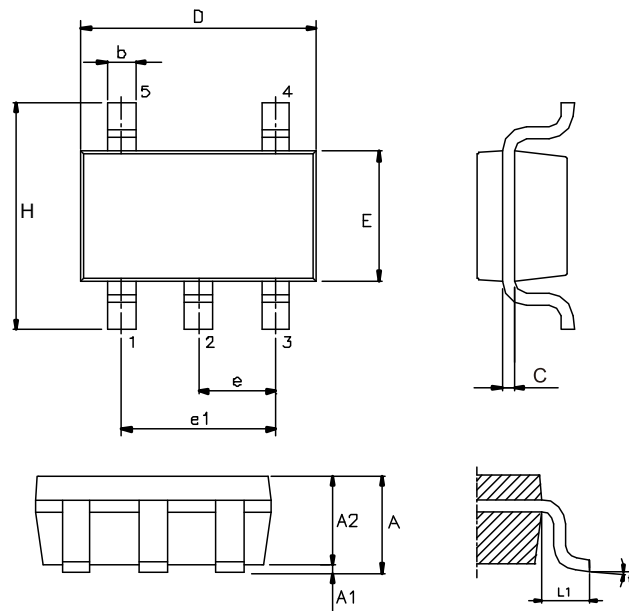

Symbol	Dimensions in inch		
	Min.	Nom.	Max.
A	—	—	0.057
A1	—	—	0.006
A2	0.035	0.045	0.051
b	0.012	—	0.020
C	0.003	—	0.009
D	—	0.114 BSC	—
E	—	0.063 BSC	—
e	—	0.037 BSC	—
e1	—	0.075 BSC	—
H	—	0.110 BSC	—
L1	—	0.024 BSC	—
θ	0°	—	8°

Symbol	Dimensions in mm		
	Min.	Nom.	Max.
A	—	—	1.45
A1	—	—	0.15
A2	0.90	1.15	1.30
b	0.30	—	0.50
C	0.08	—	0.22
D	—	2.90 BSC	—
E	—	1.60 BSC	—
e	—	0.95 BSC	—
e1	—	1.90 BSC	—
H	—	2.80 BSC	—
L1	—	0.60 BSC	—
θ	0°	—	8°

3-pin SOT89 Outline Dimensions

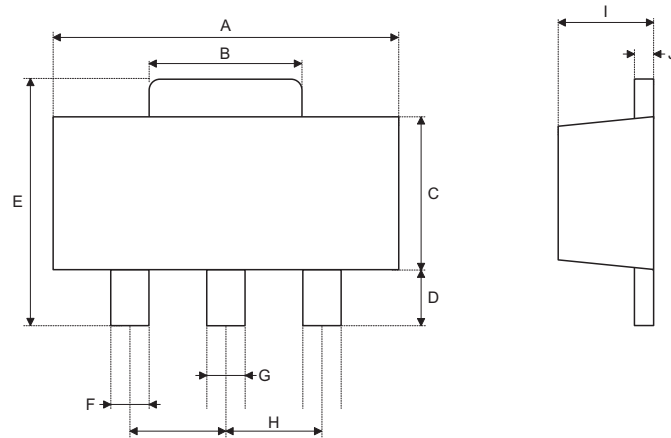

Symbol	Dimensions in inch		
	Min.	Nom.	Max.
A	0.173	—	0.185
B	0.053	—	0.072
C	0.090	—	0.106
D	0.031	—	0.047
E	0.155	—	0.173
F	0.014	—	0.019
G	0.017	—	0.022
H	—	0.059 BSC	—
I	0.055	—	0.063
J	0.014	—	0.017

Symbol	Dimensions in mm		
	Min.	Nom.	Max.
A	4.40	—	4.70
B	1.35	—	1.83
C	2.29	—	2.70
D	0.80	—	1.20
E	3.94	—	4.40
F	0.36	—	0.48
G	0.44	—	0.56
H	—	1.50 BSC	—
I	1.40	—	1.60
J	0.35	—	0.44

Copyright© 2021 by HOLTEK SEMICONDUCTOR INC.

The information appearing in this Data Sheet is believed to be accurate at the time of publication. However, Holtek assumes no responsibility arising from the use of the specifications described. The applications mentioned herein are used solely for the purpose of illustration and Holtek makes no warranty or representation that such applications will be suitable without further modification, nor recommends the use of its products for application that may present a risk to human life due to malfunction or otherwise. Holtek's products are not authorized for use as critical components in life support devices or systems. Holtek reserves the right to alter its products without prior notification. For the most up-to-date information, please visit our web site at <http://www.holtek.com>.