



30mA TinyPower™ LDO

HT71xx-2

Revision: V1.60 Date: April 10, 2024

www.holtek.com

Table of Contents

Features	3
Applications	3
General Description	3
Selection Table	3
Block Diagram	4
Pin Assignment	4
Absolute Maximum Ratings	4
Thermal Information	5
Electrical Characteristics	5
HT7121-2, +2.1V Output Type	5
HT7123-2, +2.3V Output Type	5
HT7125-2, +2.5V Output Type	6
HT7127-2, +2.7V Output Type	6
HT7130-2, +3.0V Output Type	7
HT7133-2, +3.3V Output Type	7
HT7136-2, +3.6V Output Type	8
HT7144-2, +4.4V Output Type	8
HT7150-2, +5.0V Output Type	9
Typical Performance Characteristics	9
Application Circuits	11
Basic Circuits	11
High Output Current Positive Voltage Regulator.....	11
Short-Circuit Protection by Tr1	12
Circuit for Increasing Output Voltage	12
Circuit for Increasing Output Voltage	12
Constant Current Regulator	12
Dual Supply.....	13
Package Information	14
3-pin SOT89 Outline Dimensions.....	15
5-pin SOT23 Outline Dimensions.....	16

Features

- Low power consumption
- Low voltage drop
- Low temperature coefficient
- High input voltage (up to 30V)
- Output voltage accuracy: tolerance $\pm 1\%$
- Package types: 3-pin SOT89 and 5-pin SOT23

Applications

- Battery-powered equipment
- Communication equipment
- Audio/Video equipment

General Description

The HT71xx-2 series is a set of three-terminal low power high voltage regulators implemented in CMOS technology. They allow input voltages as high as 30V. They are available with several fixed output voltages ranging from 2.1V to 5.0V. CMOS technology ensures low voltage drop and low quiescent current.

Although designed primarily as fixed voltage regulators, these devices can be used with external components to obtain variable voltages and currents.

Selection Table

Part No.	Output Voltage	Package	Marking
HT7121-2	2.1V	SOT89 SOT23-5	71xx-2 (for SOT89) 1xx2 (for SOT23-5)
HT7123-2	2.3V		
HT7125-2	2.5V		
HT7127-2	2.7V		
HT7130-2	3.0V		
HT7133-2	3.3V		
HT7136-2	3.6V		
HT7144-2	4.4V		
HT7150-2	5.0V		

Note: "xx" stands for output voltages.

Block Diagram

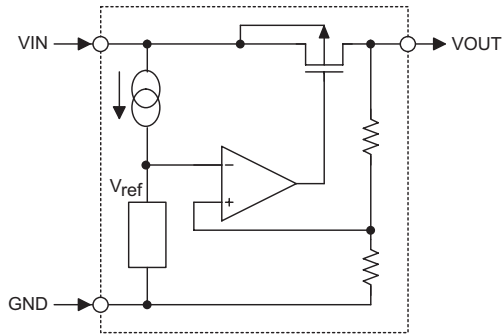

Pin Assignment

SOT89

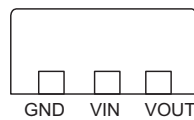
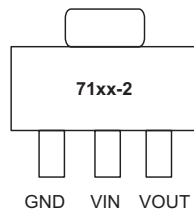

SOT23-5

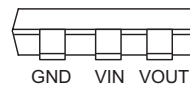
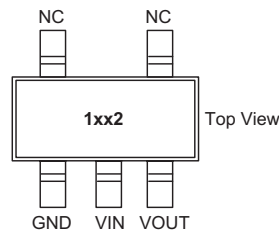

Absolute Maximum Ratings

Supply Voltage	-0.3V to 33V
Storage Temperature	-60°C to 150°C
Operating Temperature	-40°C to 85°C
Maximum Junction Temperature.....	150°C

Note: These are stress ratings only. Stresses exceeding the range specified under "Absolute Maximum Ratings" may cause substantial damage to the device. Functional operation of this device at other conditions beyond those listed in the specification is not implied and prolonged exposure to extreme conditions may affect device reliability.

Thermal Information

Symbol	Parameter	Package	Max.	Unit
θ_{JA}	Thermal Resistance (Junction to Ambient) (Assume no ambient airflow, no heat sink)	SOT23-5	500	°C/W
		SOT89	200	°C/W
P_D	Power Dissipation	SOT23-5	0.20	W
		SOT89	0.50	W

Note: P_D is measured at $T_a = 25^\circ\text{C}$

Electrical Characteristics

HT7121-2, +2.1V Output Type

$T_a = 25^\circ\text{C}$

Symbol	Parameter	Test Conditions		Min.	Typ.	Max.	Unit
		V_{IN}	Conditions				
V_{IN}	Input Voltage	—	—	—	—	30	V
V_{OUT}	Output Voltage	4.1V	$I_{OUT} = 10\text{mA}$	2.079	2.100	2.121	V
I_{OUT}	Output Current	4.1V	—	20	30	—	mA
ΔV_{OUT}	Load Regulation	4.1V	$1\text{mA} \leq I_{OUT} \leq 20\text{mA}$	—	15	45	mV
V_{DIF}	Dropout Voltage ^(Note)	—	$I_{OUT} = 1\text{mA}, \Delta V_{OUT} = 2\%$	—	35	100	mV
I_{SS}	Quiescent Current	4.1V	No load	—	2.5	4.0	μA
$\frac{\Delta V_{OUT}}{\Delta V_{IN} \times V_{OUT}}$	Line Regulation	—	$3.1\text{V} \leq V_{IN} \leq 30\text{V}, I_{OUT} = 1\text{mA}$	—	0.1	0.2	%/V
$\frac{\Delta V_{OUT}}{\Delta T_a \times V_{OUT}}$	Temperature Coefficient	4.1V	$I_{OUT} = 10\text{mA}, -40^\circ\text{C} < T_a < 85^\circ\text{C}$	—	± 100	—	ppm/°C

Note: Dropout voltage is defined as the input voltage minus the output voltage that produces a 2% change in the output voltage from the value at $V_{IN} = V_{OUT} + 2\text{V}$ with a fixed load.

HT7123-2, +2.3V Output Type

$T_a = 25^\circ\text{C}$

Symbol	Parameter	Test Conditions		Min.	Typ.	Max.	Unit
		V_{IN}	Conditions				
V_{IN}	Input Voltage	—	—	—	—	30	V
V_{OUT}	Output Voltage	4.3V	$I_{OUT} = 10\text{mA}$	2.277	2.300	2.323	V
I_{OUT}	Output Current	4.3V	—	20	30	—	mA
ΔV_{OUT}	Load Regulation	4.3V	$1\text{mA} \leq I_{OUT} \leq 20\text{mA}$	—	15	45	mV
V_{DIF}	Dropout Voltage ^(Note)	—	$I_{OUT} = 1\text{mA}, \Delta V_{OUT} = 2\%$	—	35	100	mV
I_{SS}	Quiescent Current	4.3V	No load	—	2.5	4.0	μA
$\frac{\Delta V_{OUT}}{\Delta V_{IN} \times V_{OUT}}$	Line Regulation	—	$3.3\text{V} \leq V_{IN} \leq 30\text{V}, I_{OUT} = 1\text{mA}$	—	0.1	0.2	%/V
$\frac{\Delta V_{OUT}}{\Delta T_a \times V_{OUT}}$	Temperature Coefficient	4.3V	$I_{OUT} = 10\text{mA}, -40^\circ\text{C} < T_a < 85^\circ\text{C}$	—	± 100	—	ppm/°C

Note: Dropout voltage is defined as the input voltage minus the output voltage that produces a 2% change in the output voltage from the value at $V_{IN} = V_{OUT} + 2\text{V}$ with a fixed load.

HT7125-2, +2.5V Output Type

Ta=25°C

Symbol	Parameter	Test Conditions		Min.	Typ.	Max.	Unit
		V _{IN}	Conditions				
V _{IN}	Input Voltage	—	—	—	—	30	V
V _{OUT}	Output Voltage	4.5V	I _{OUT} =10mA	2.475	2.500	2.525	V
I _{OUT}	Output Current	4.5V	—	20	30	—	mA
ΔV _{OUT}	Load Regulation	4.5V	1mA ≤ I _{OUT} ≤ 20mA	—	15	45	mV
V _{DIF}	Dropout Voltage ^(Note)	—	I _{OUT} =1mA, ΔV _{OUT} =2%	—	35	100	mV
I _{SS}	Quiescent Current	4.5V	No load	—	2.5	4.0	μA
$\frac{\Delta V_{OUT}}{\Delta V_{IN} \times V_{OUT}}$	Line Regulation	—	3.5V ≤ V _{IN} ≤ 30V, I _{OUT} =1mA	—	0.1	0.2	%/V
$\frac{\Delta V_{OUT}}{\Delta T_a \times V_{OUT}}$	Temperature Coefficient	4.5V	I _{OUT} =10mA, -40°C < Ta < 85°C	—	±100	—	ppm/°C

Note: Dropout voltage is defined as the input voltage minus the output voltage that produces a 2% change in the output voltage from the value at V_{IN} = V_{OUT}+2V with a fixed load.

HT7127-2, +2.7V Output Type

Ta=25°C

Symbol	Parameter	Test Conditions		Min.	Typ.	Max.	Unit
		V _{IN}	Conditions				
V _{IN}	Input Voltage	—	—	—	—	30	V
V _{OUT}	Output Voltage	4.7V	I _{OUT} =10mA	2.673	2.700	2.727	V
I _{OUT}	Output Current	4.7V	—	20	30	—	mA
ΔV _{OUT}	Load Regulation	4.7V	1mA ≤ I _{OUT} ≤ 20mA	—	15	45	mV
V _{DIF}	Dropout Voltage ^(Note)	—	I _{OUT} =1mA, ΔV _{OUT} =2%	—	35	100	mV
I _{SS}	Quiescent Current	4.7V	No load	—	2.5	4.0	μA
$\frac{\Delta V_{OUT}}{\Delta V_{IN} \times V_{OUT}}$	Line Regulation	—	3.7V ≤ V _{IN} ≤ 30V, I _{OUT} =1mA	—	0.1	0.2	%/V
$\frac{\Delta V_{OUT}}{\Delta T_a \times V_{OUT}}$	Temperature Coefficient	4.7V	I _{OUT} =10mA, -40°C < Ta < 85°C	—	±100	—	ppm/°C

Note: Dropout voltage is defined as the input voltage minus the output voltage that produces a 2% change in the output voltage from the value at V_{IN} = V_{OUT}+2V with a fixed load.

HT7130-2, +3.0V Output Type

Ta=25°C

Symbol	Parameter	Test Conditions		Min.	Typ.	Max.	Unit
		V _{IN}	Conditions				
V _{IN}	Input Voltage	—	—	—	—	30	V
V _{OUT}	Output Voltage	5V	I _{OUT} =10mA	2.97	3.00	3.03	V
I _{OUT}	Output Current	5V	—	20	30	—	mA
ΔV _{OUT}	Load Regulation	5V	1mA ≤ I _{OUT} ≤ 20mA	—	15	45	mV
V _{DIF}	Dropout Voltage ^(Note)	—	I _{OUT} =1mA, ΔV _{OUT} =2%	—	35	100	mV
I _{SS}	Quiescent Current	5V	No load	—	2.5	4.0	μA
$\frac{\Delta V_{OUT}}{\Delta V_{IN} \times V_{OUT}}$	Line Regulation	—	4V ≤ V _{IN} ≤ 30V, I _{OUT} =1mA	—	0.1	0.2	%/V
$\frac{\Delta V_{OUT}}{\Delta T_a \times V_{OUT}}$	Temperature Coefficient	5V	I _{OUT} =10mA, -40°C < Ta < 85°C	—	±100	—	ppm/°C

Note: Dropout voltage is defined as the input voltage minus the output voltage that produces a 2% change in the output voltage from the value at V_{IN} = V_{OUT}+2V with a fixed load.

HT7133-2, +3.3V Output Type

Ta=25°C

Symbol	Parameter	Test Conditions		Min.	Typ.	Max.	Unit
		V _{IN}	Conditions				
V _{IN}	Input Voltage	—	—	—	—	30	V
V _{OUT}	Output Voltage	5.3V	I _{OUT} =10mA	3.267	3.300	3.333	V
I _{OUT}	Output Current	5.3V	—	20	30	—	mA
ΔV _{OUT}	Load Regulation	5.3V	1mA ≤ I _{OUT} ≤ 30mA	—	15	45	mV
V _{DIF}	Dropout Voltage ^(Note)	—	I _{OUT} =1mA, ΔV _{OUT} =2%	—	35	55	mV
I _{SS}	Quiescent Current	5.3V	No load	—	2.5	4.0	μA
$\frac{\Delta V_{OUT}}{\Delta V_{IN} \times V_{OUT}}$	Line Regulation	—	4.3V ≤ V _{IN} ≤ 30V, I _{OUT} =1mA	—	0.1	0.2	%/V
$\frac{\Delta V_{OUT}}{\Delta T_a \times V_{OUT}}$	Temperature Coefficient	5.3V	I _{OUT} =10mA, -40°C < Ta < 85°C	—	±100	—	ppm/°C

Note: Dropout voltage is defined as the input voltage minus the output voltage that produces a 2% change in the output voltage from the value at V_{IN} = V_{OUT}+2V with a fixed load.

HT7136-2, +3.6V Output Type

Ta=25°C

Symbol	Parameter	Test Conditions		Min.	Typ.	Max.	Unit
		V _{IN}	Conditions				
V _{IN}	Input Voltage	—	—	—	—	30	V
V _{OUT}	Output Voltage	5.6V	I _{OUT} =10mA	3.564	3.600	3.636	V
I _{OUT}	Output Current	5.6V	—	20	30	—	mA
ΔV _{OUT}	Load Regulation	5.6V	1mA ≤ I _{OUT} ≤ 30mA	—	15	45	mV
V _{DIF}	Dropout Voltage ^(Note)	—	I _{OUT} =1mA, ΔV _{OUT} =2%	—	35	55	mV
I _{SS}	Quiescent Current	5.6V	No load	—	2.5	4.0	μA
$\frac{\Delta V_{OUT}}{\Delta V_{IN} \times V_{OUT}}$	Line Regulation	—	4.6V ≤ V _{IN} ≤ 30V, I _{OUT} =1mA	—	0.1	0.2	%/V
$\frac{\Delta V_{OUT}}{\Delta T_a \times V_{OUT}}$	Temperature Coefficient	5.6V	I _{OUT} =10mA, -40°C < Ta < 85°C	—	±100	—	ppm/°C

Note: Dropout voltage is defined as the input voltage minus the output voltage that produces a 2% change in the output voltage from the value at V_{IN} = V_{OUT}+2V with a fixed load.

HT7144-2, +4.4V Output Type

Ta=25°C

Symbol	Parameter	Test Conditions		Min.	Typ.	Max.	Unit
		V _{IN}	Conditions				
V _{IN}	Input Voltage	—	—	—	—	30	V
V _{OUT}	Output Voltage	6.4V	I _{OUT} =10mA	4.356	4.400	4.444	V
I _{OUT}	Output Current	6.4V	—	20	30	—	mA
ΔV _{OUT}	Load Regulation	6.4V	1mA ≤ I _{OUT} ≤ 30mA	—	15	45	mV
V _{DIF}	Dropout Voltage ^(Note)	—	I _{OUT} =1mA, ΔV _{OUT} =2%	—	35	55	mV
I _{SS}	Quiescent Current	6.4V	No load	—	2.5	4.0	μA
$\frac{\Delta V_{OUT}}{\Delta V_{IN} \times V_{OUT}}$	Line Regulation	—	5.4V ≤ V _{IN} ≤ 30V, I _{OUT} =1mA	—	0.1	0.2	%/V
$\frac{\Delta V_{OUT}}{\Delta T_a \times V_{OUT}}$	Temperature Coefficient	6.4V	I _{OUT} =10mA, -40°C < Ta < 85°C	—	±100	—	ppm/°C

Note: Dropout voltage is defined as the input voltage minus the output voltage that produces a 2% change in the output voltage from the value at V_{IN} = V_{OUT}+2V with a fixed load.

HT7150-2, +5.0V Output Type

Ta=25°C

Symbol	Parameter	Test Conditions		Min.	Typ.	Max.	Unit
		V _{IN}	Conditions				
V _{IN}	Input Voltage	—	—	—	—	30	V
V _{OUT}	Output Voltage	7V	I _{OUT} =10mA	4.95	5.00	5.05	V
I _{OUT}	Output Current	7V	—	20	30	—	mA
ΔV _{OUT}	Load Regulation	7V	1mA ≤ I _{OUT} ≤ 30mA	—	15	45	mV
V _{DIF}	Dropout Voltage ^(Note)	—	I _{OUT} =1mA, ΔV _{OUT} =2%	—	35	55	mV
I _{SS}	Quiescent Current	7V	No load	—	2.5	4.0	μA
$\frac{\Delta V_{OUT}}{\Delta V_{IN} \times V_{OUT}}$	Line Regulation	—	6V ≤ V _{IN} ≤ 30V, I _{OUT} =1mA	—	0.1	0.2	%/V
$\frac{\Delta V_{OUT}}{\Delta T_a \times V_{OUT}}$	Temperature Coefficient	7V	I _{OUT} =10mA, -40°C < T _a < 85°C	—	±100	—	ppm/°C

Note: Dropout voltage is defined as the input voltage minus the output voltage that produces a 2% change in the output voltage from the value at V_{IN} = V_{OUT}+2V with a fixed load.

Typical Performance Characteristics

Test Condition: V_{in}=V_{out}+2V, I_{OUT}=10mA, T_J=25°C, unless otherwise noted

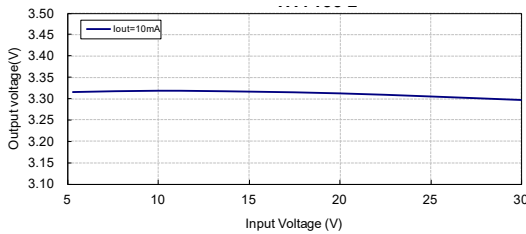

Output Voltage vs Input Voltage: HT7133-2

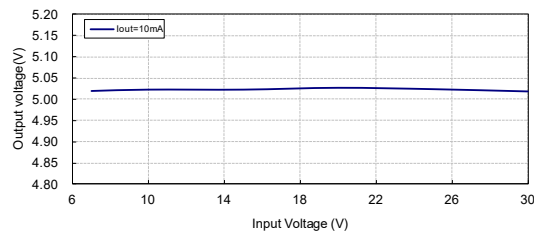

Output Voltage vs Input Voltage: HT7150-2

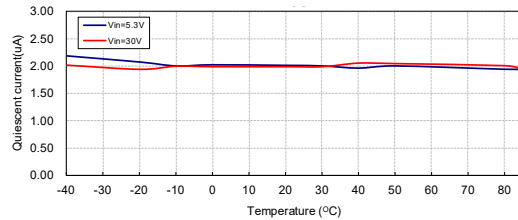

Quiescent Current vs Temperature: HT7133-2
(I_{OUT}=0mA)

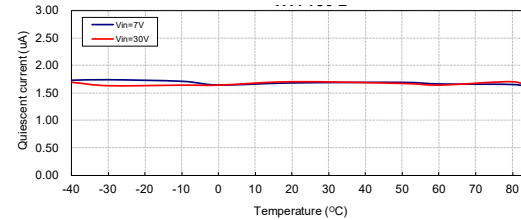

Quiescent Current vs Temperature: HT7150-2
(I_{OUT}=0mA)

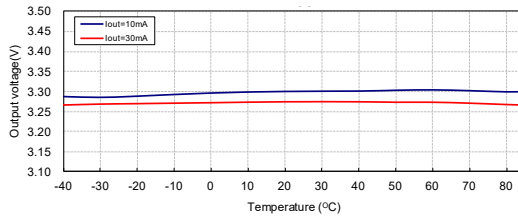

Output Voltage vs Temperature: HT7133-2
(V_{IN}=V_{OUT}+2V)

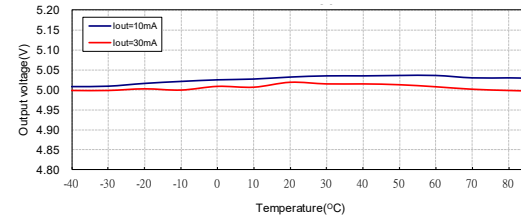

Output Voltage vs Temperature: HT7150-2
(V_{IN}=V_{OUT}+2V)

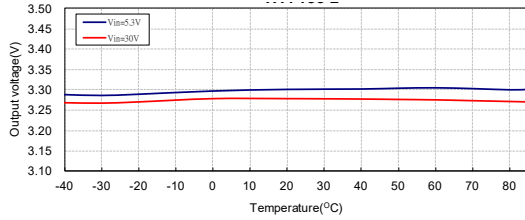

Output Voltage vs Temperature: HT7133-2

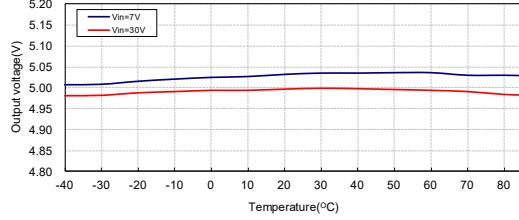

Output Voltage vs Temperature: HT7150-2

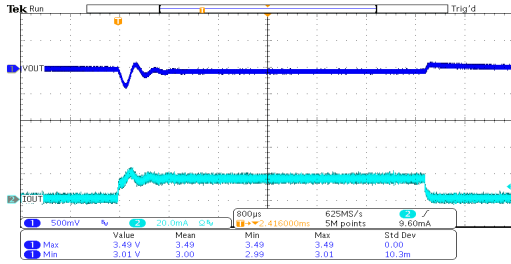

Load Transient Response: HT7133-2
(V_{IN}=5.3V, I_{OUT}=0mA~15mA)

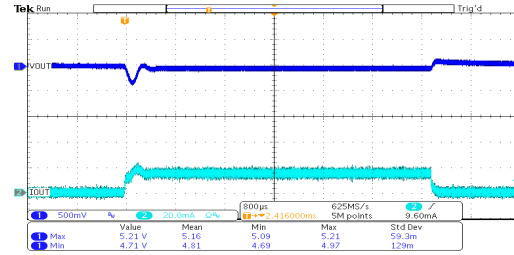

Load Transient Response: HT7150-2
(V_{IN}=7V, I_{OUT}=0mA~15mA)

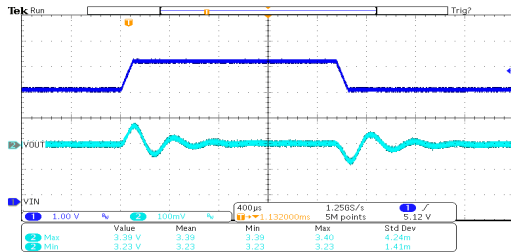

Line Transient Response: HT7133-2
(V_{IN}=4.3V~5.3V, I_{OUT}=10mA)

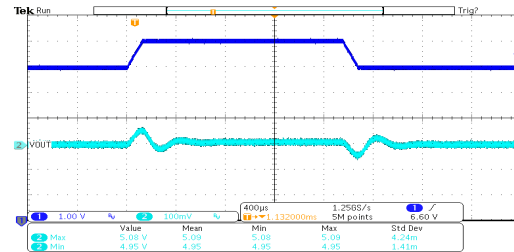

Line Transient Response: HT7150-2
(V_{IN}=6V~7V, I_{OUT}=10mA)

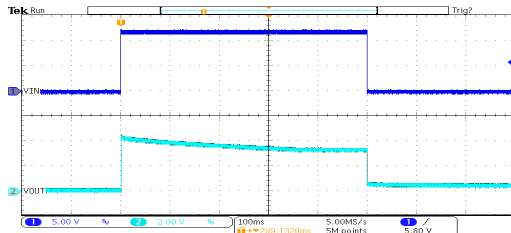

Power ON/OFF Response: HT7133-2
(V_{IN}=12V, I_{OUT}=0mA, TRISE=TFALL=0.1ms)

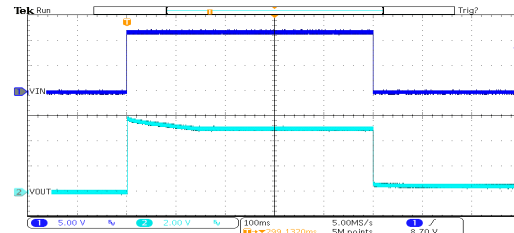

Power ON/OFF Response: HT7150-2
(V_{IN}=12V, I_{OUT}=0mA, TRISE=TFALL=0.1ms)

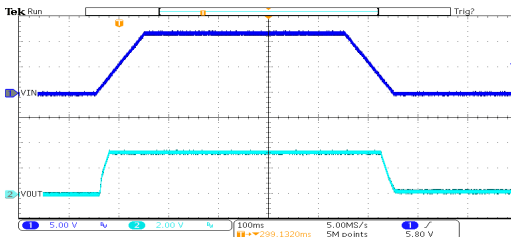

Power ON/OFF Response: HT7133-2
(V_{IN}=12V, I_{OUT}=0mA, TRISE=TFALL=100ms)

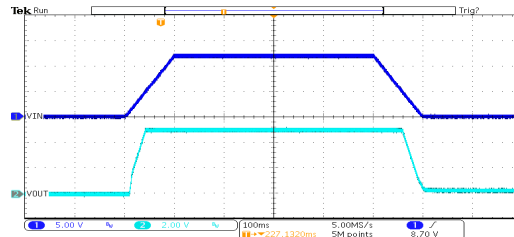

Power ON/OFF Response: HT7150-2
(V_{IN}=12V, I_{OUT}=0mA, TRISE=TFALL=100ms)

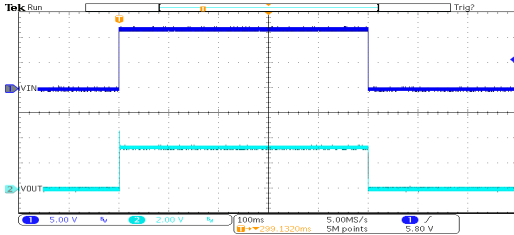

Power ON/OFF Response: HT7133-2
($V_{IN}=12V$, $I_{OUT}=30mA$, $TRISE=TFALL=0.1ms$)

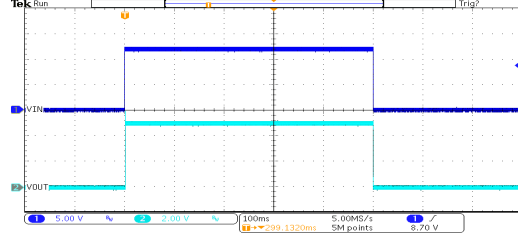

Power ON/OFF Response: HT7150-2
($V_{IN}=12V$, $I_{OUT}=30mA$, $TRISE=TFALL=0.1ms$)

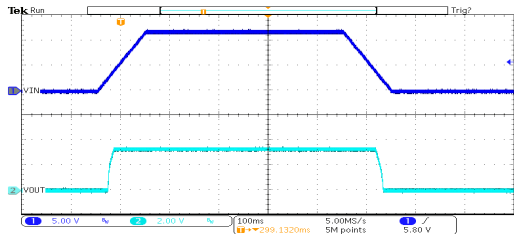

Power ON/OFF Response: HT7133-2
($V_{IN}=12V$, $I_{OUT}=30mA$, $TRISE=TFALL=100ms$)

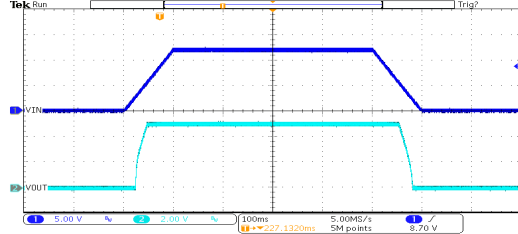

Power ON/OFF Response: HT7150-2
($V_{IN}=12V$, $I_{OUT}=30mA$, $TRISE=TFALL=100ms$)

Application Circuits

Basic Circuits

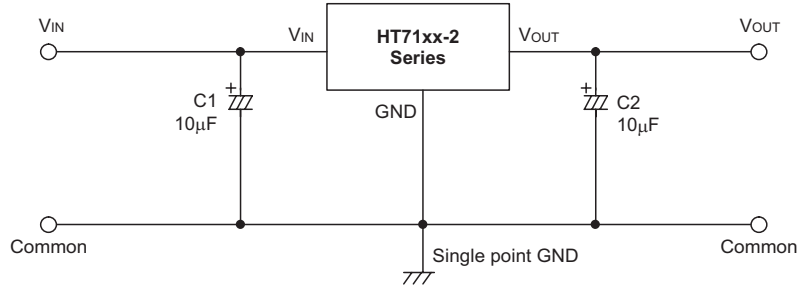

High Output Current Positive Voltage Regulator

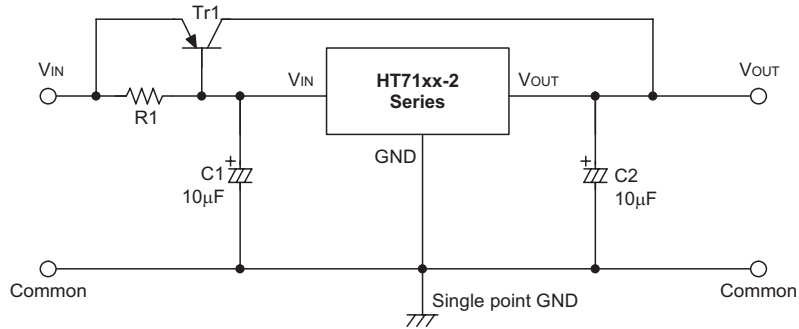

Short-Circuit Protection by Tr1

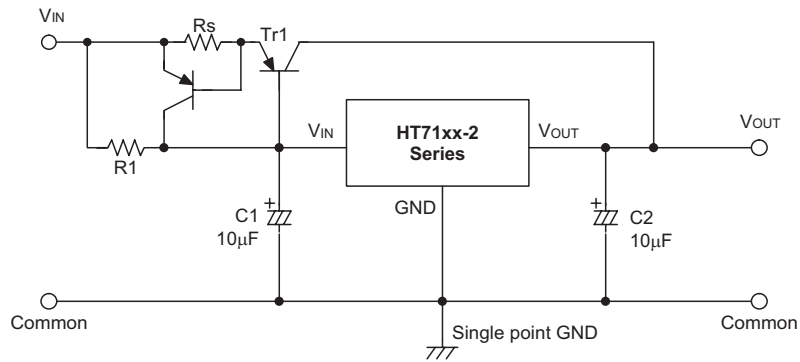

Circuit for Increasing Output Voltage

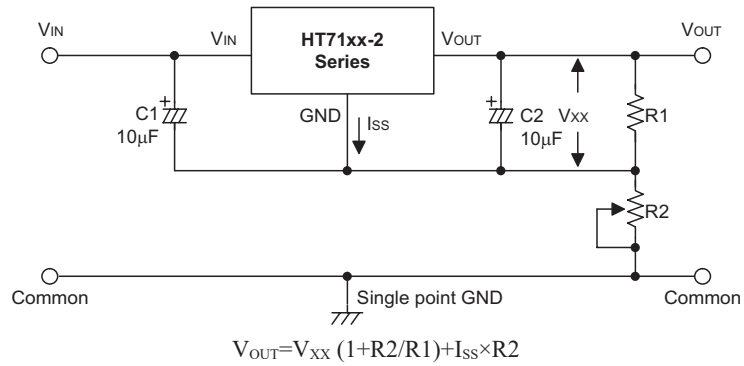

Circuit for Increasing Output Voltage

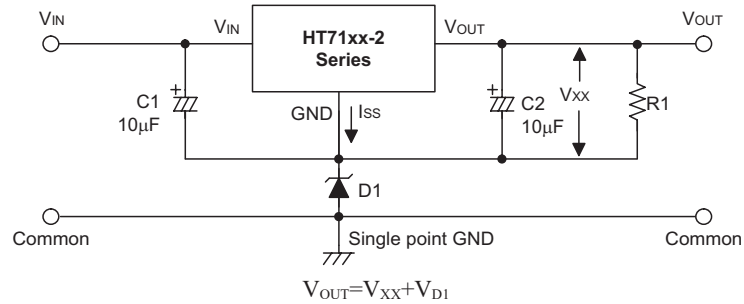

Constant Current Regulator

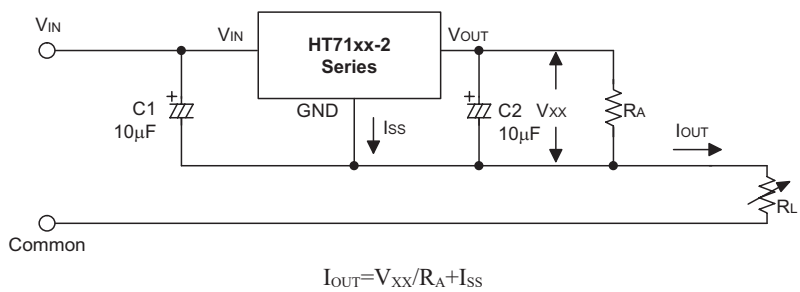

Dual Supply

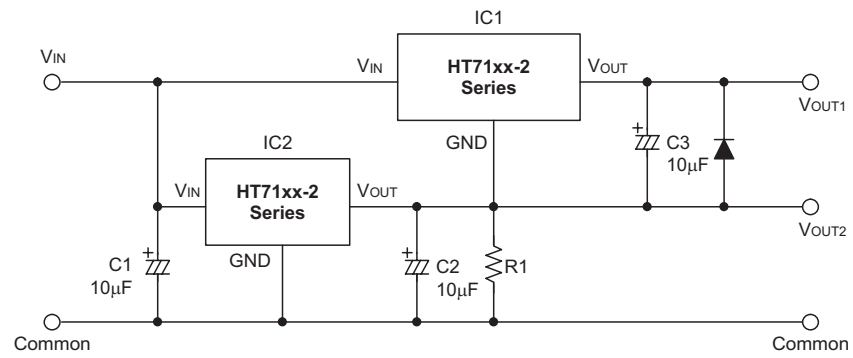

Package Information

Note that the package information provided here is for consultation purposes only. As this information may be updated at regular intervals users are reminded to consult the [Holtek website](#) for the latest version of the [Package/Carton Information](#).

Additional supplementary information with regard to packaging is listed below. Click on the relevant section to be transferred to the relevant website page.

- [Package Information \(include Outline Dimensions, Product Tape and Reel Specifications\)](#)
- [The Operation Instruction of Packing Materials](#)
- [Carton information](#)

3-pin SOT89 Outline Dimensions

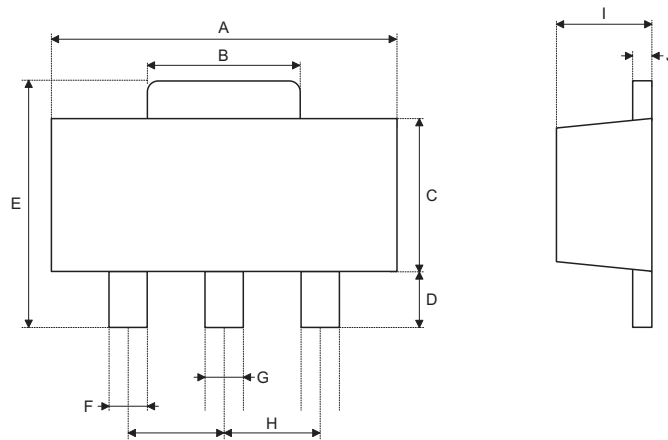

Symbol	Dimensions in inch		
	Min.	Nom.	Max.
A	0.173	—	0.185
B	0.053	—	0.072
C	0.090	—	0.106
D	0.031	—	0.047
E	0.155	—	0.173
F	0.014	—	0.019
G	0.017	—	0.022
H	0.059 BSC		
I	0.055	—	0.063
J	0.014	—	0.017

Symbol	Dimensions in mm		
	Min.	Nom.	Max.
A	4.40	—	4.70
B	1.35	—	1.83
C	2.29	—	2.70
D	0.80	—	1.20
E	3.94	—	4.40
F	0.36	—	0.48
G	0.44	—	0.56
H	1.50 BSC		
I	1.40	—	1.60
J	0.35	—	0.44

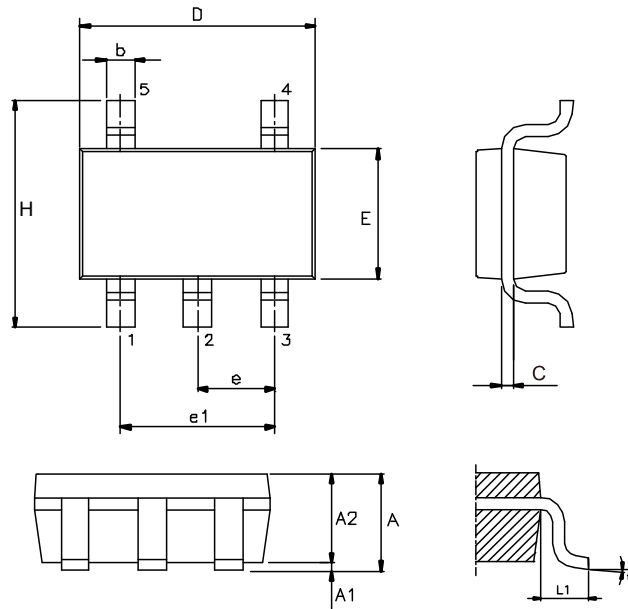
5-pin SOT23 Outline Dimensions

Symbol	Dimensions in inch		
	Min.	Nom.	Max.
A	—	—	0.057
A1	—	—	0.006
A2	0.035	0.045	0.051
b	0.012	—	0.020
C	0.003	—	0.009
D	0.114 BSC		
E	0.063 BSC		
e	0.037 BSC		
e1	0.075 BSC		
H	0.110 BSC		
L1	0.024 BSC		
θ	0°	—	8°

Symbol	Dimensions in mm		
	Min.	Nom.	Max.
A	—	—	1.45
A1	—	—	0.15
A2	0.90	1.15	1.30
b	0.30	—	0.50
C	0.08	—	0.22
D	2.90 BSC		
E	1.60 BSC		
e	0.95 BSC		
e1	1.90 BSC		
H	2.80 BSC		
L1	0.60 BSC		
θ	0°	—	8°

Copyright© 2024 by HOLTEK SEMICONDUCTOR INC. All Rights Reserved.

The information provided in this document has been produced with reasonable care and attention before publication, however, HOLTEK does not guarantee that the information is completely accurate. The information contained in this publication is provided for reference only and may be superseded by updates. HOLTEK disclaims any expressed, implied or statutory warranties, including but not limited to suitability for commercialization, satisfactory quality, specifications, characteristics, functions, fitness for a particular purpose, and non-infringement of any third-party's rights. HOLTEK disclaims all liability arising from the information and its application. In addition, HOLTEK does not recommend the use of HOLTEK's products where there is a risk of personal hazard due to malfunction or other reasons. HOLTEK hereby declares that it does not authorize the use of these products in life-saving, life-sustaining or safety critical components. Any use of HOLTEK's products in life-saving/sustaining or safety applications is entirely at the buyer's risk, and the buyer agrees to defend, indemnify and hold HOLTEK harmless from any damages, claims, suits, or expenses resulting from such use. The information provided in this document, including but not limited to the content, data, examples, materials, graphs, and trademarks, is the intellectual property of HOLTEK (and its licensors, where applicable) and is protected by copyright law and other intellectual property laws. No license, express or implied, to any intellectual property right, is granted by HOLTEK herein. HOLTEK reserves the right to revise the information described in the document at any time without prior notice. For the latest information, please contact us.