

### Features

- Operating voltage:
  - 1.8V~5.5V for temperature -40°C to +85°C
- Low power consumption
  - Operation: 5mA max.
  - Standby: 3µA max.
- Internal organization: 2048×8
- 2-wire serial interface
- Write cycle time: 5ms max.
- Automatic erase-before-write operation
- Partial page write allowed
- 16-byte Page Write Mode
- Write operation with built-in timer
- Hardware controlled write protection
- 40-year data retention
- 10<sup>6</sup> rewrite cycles per word
- 8-pin SOP package

### General Description

The HT24LC16 is a 16K-bit serial read/write non-volatile memory device using the CMOS floating gate process. Its 16384 bits of memory are organized into 2048 words and each word is 8 bits. The device is optimized for use in many industrial and commercial applications where low power and low voltage operation are essential. Only one HT24LC16 device may be connected to the same 2-wire bus. The HT24LC16 is guaranteed for 1M erase/write cycles and 40-year data retention.

### Pin Description

Pin Name	I/O	Description
A0~A2	I	Address inputs. A0, A1 not connected.
SDA	I/O	Serial data
SCL	I	Serial clock input
WP	I	Write protect
VSS	—	Negative power supply, ground
VCC	—	Positive power supply

### Block Diagram

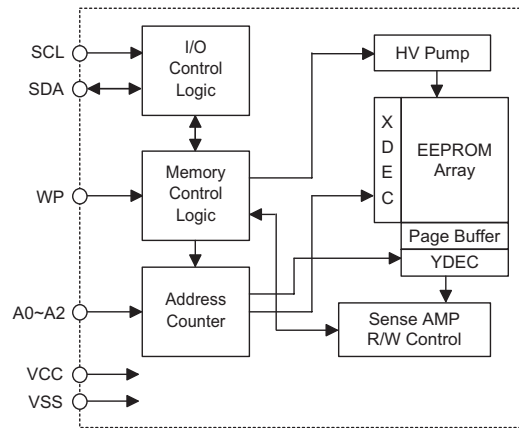

### Pin Assignment

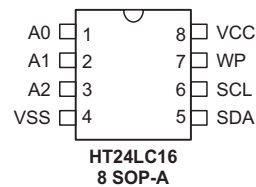

## Absolute Maximum Ratings

Supply Voltage .....  $V_{SS}-0.3V$  to  $V_{SS}+6.0V$       Storage Temperature .....  $-50^{\circ}C$  to  $125^{\circ}C$   
 Input Voltage .....  $V_{SS}-0.3V$  to  $V_{CC}+0.3V$       Operating Temperature .....  $-40^{\circ}C$  to  $85^{\circ}C$

Note: These are stress ratings only. Stresses exceeding the range specified under "Absolute Maximum Ratings" may cause substantial damage to the device. Functional operation of this device at other conditions beyond those listed in the specification is not implied and prolonged exposure to extreme conditions may affect device reliability.

## D.C. Characteristics

 $T_a = -40^{\circ}C \sim +85^{\circ}C$ 

Symbol	Parameter	Test Conditions		Min.	Typ.	Max.	Unit
		V <sub>CC</sub>	Conditions				
V <sub>CC</sub>	Operating Voltage	—	$-40^{\circ}C$ to $+85^{\circ}C$	1.8	—	5.5	V
I <sub>CC1</sub>	Operating Current	5V	Read at 400kHz	—	—	2	mA
I <sub>CC2</sub>	Operating Current	5V	Write at 400kHz	—	—	5	mA
V <sub>IL</sub>	Input Low Voltage	—	—	-0.45	—	0.3V <sub>CC</sub>	V
V <sub>IH</sub>	Input High Voltage	—	—	0.7V <sub>CC</sub>	—	V <sub>CC</sub> +0.5	V
V <sub>OL</sub>	Output Low Voltage	2.4V	I <sub>OL</sub> =2.1mA	—	—	0.4	V
		1.8V	I <sub>OL</sub> =0.7mA	—	—	0.2	V
I <sub>LI</sub>	Input Leakage Current	5V	V <sub>IN</sub> =0 or V <sub>CC</sub>	—	—	1	μA
I <sub>LO</sub>	Output Leakage Current	5V	V <sub>OUT</sub> =0 or V <sub>CC</sub>	—	—	1	μA
I <sub>STB</sub>	Standby Current	5V	V <sub>IN</sub> =0 or V <sub>CC</sub>	—	—	3	μA
			SDA, SCL=V <sub>CC</sub> WP=V <sub>SS</sub>	—	—	1	μA
		1.8V	V <sub>IN</sub> =0 or V <sub>CC</sub> SDA, SCL=V <sub>CC</sub> WP=V <sub>SS</sub>	—	—	1	μA
C <sub>IN</sub>	Input Capacitance (See Note)	—	f=1MHz, 25°C	—	—	6	pF
C <sub>OUT</sub>	Output Capacitance (See Note)	—	f=1MHz, 25°C	—	—	8	pF

Note: These parameters are periodically sampled but not 100% tested.

**A.C. Characteristics**

Ta=-40°C~+85°C

Symbol	Parameter	Remark	V <sub>CC</sub> =1.8V~5.0V		V <sub>CC</sub> =2.5V~5.0V		Unit
			Min.	Max.	Min.	Max.	
f <sub>SK</sub>	Clock Frequency	—	—	400	—	1000	kHz
t <sub>HIGH</sub>	Clock High Time	—	600	—	400	—	ns
t <sub>LOW</sub>	Clock Low Time	—	1200	—	600	—	ns
t <sub>r</sub>	SDA and SCL Rise Time	Note	—	300	—	300	ns
t <sub>f</sub>	SDA and SCL Fall Time	Note	—	300	—	300	ns
t <sub>HD:STA</sub>	START Condition Hold Time	After this period the first clock pulse is generated	600	—	250	—	ns
t <sub>SU:STA</sub>	START Condition Setup Time	Only relevant for repeated START condition	600	—	250	—	ns
t <sub>HD:DAT</sub>	Data Input Hold Time	—	0	—	0	—	ns
t <sub>SU:DAT</sub>	Data Input Setup Time	—	150	—	100	—	ns
t <sub>SU:STO</sub>	STOP Condition Setup Time	—	600	—	250	—	ns
t <sub>AA</sub>	Output Valid from Clock	—	—	900	—	600	ns
t <sub>BUF</sub>	Bus Free Time	Time in which the bus must be free before a new transmission can start	1200	—	500	—	ns
t <sub>SP</sub>	Input Filter Time Constant (SDA and SCL Pins)	Noise suppression time	—	50	—	50	ns
t <sub>WR</sub>	Write Cycle Time	—	—	5	—	5	ms
Endurance	25°C, Page Mode	5.0V	1,000,000				Write Cycles

Note: These parameters are periodically sampled but not 100% tested.  
 For relative timing, refer to timing diagrams.

## Functional Description

- **Serial clock – SCL**  
The SCL input is used for positive edge clock data into each EEPROM device and negative edge clock data out of each device.
- **Serial data –SDA**  
The SDA pin is bidirectional for serial data transfer. The pin is open-drain driven and may be wired-OR with any number of other open-drain or open collector devices.
- **Address Inputs – A0, A1, A2**  
The HT24LC16 does not use the device address pins which limits the number of devices on a single bus to one. The A0, A1 and A2 pins have no connection.
- **Write protect – WP**  
The HT24LC16 has a write protect pin that provides hardware data protection. The write protect pin allows normal read/write operations when connected to VSS or left floating. When the write protect pin is connected to VCC, the write protection feature is enabled and operates as shown in the following table.

WP Pin Status	Protect Array
V <sub>CC</sub>	Full Array (16K)
V <sub>SS</sub> or floating	Normal Read/Write Operations

### Memory Organization

Internally organized with 2048 8-bit words, the 16K requires a 11-bit data word address for random word addressing.

### Device Operations

- **Clock and data transition**  
Data transfer may be initiated only when the bus is not busy. During data transfer, the data line must remain stable whenever the clock line is high. Changes in data line while the clock line is high will be interpreted as a START or STOP condition.
- **Start condition**  
A high-to-low transition of SDA with SCL high is a start condition which must precede any other command (refer to Start and Stop Definition Timing diagram).
- **Stop condition**  
A low-to-high transition of SDA with SCL high is a stop condition. After a read sequence, the stop command will place the EEPROM in a standby power mode (refer to Start and Stop Definition Timing Diagram).

- **Acknowledge**  
All addresses and data words are serially transmitted to and from the EEPROM in 8-bit words. The EEPROM sends a zero to acknowledge that it has received each word. This happens during the ninth clock cycle.

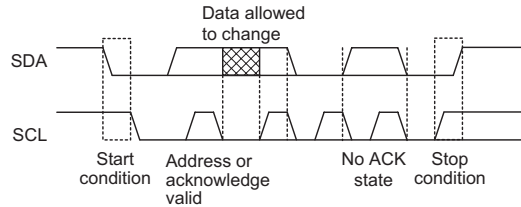

### Device Addressing

The 16K EEPROM devices require an 8-bit device address word following a start condition to enable the chip for a read or write operation. The device address word consist of a mandatory one, zero sequence for the first four most significant bits (refer to the diagram showing the Device Address). This is common to all the EEPROM device.

The 16K does not use any device address bits but instead the 3 bits are used for memory page addressing. These page addressing bits on the 16K devices should be considered the most significant bits of the data word address which follows. The A0, A1 and A2 pins have no connection.

The 8th bit device address is the read/write operation select bit. A read operation is initiated if this bit is high and a write operation is initiated if this bit is low.

If the comparison of the device address succeed the EEPROM will output a zero at ACK bit. If not, the chip will return to a standby state.

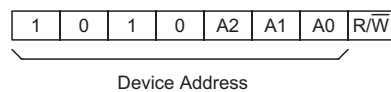

**Write Operations**

- **Byte write**  
 A write operation requires an 8-bit data word address following the device address word and acknowledgment. Upon receipt of this address, the EEPROM will again respond with a zero and then clock in the first 8-bit data word. After receiving the 8-bit data word, the EEPROM will output a zero and the addressing device, such as a microcontroller, must terminate the write sequence with a stop condition. At this time the EEPROM enters an internally-timed write cycle to the non-volatile memory. All inputs are disabled during this write cycle and EEPROM will not respond until the write is completed (refer to Byte write timing).

- **Page write**  
 The 16K EEPROM is capable of a 16-byte page write. A page write is initiated in the same way as a byte write, but the microcontroller does not send a stop condition after the first data word is clocked in. Instead, after the EEPROM acknowledges the receipt of the first data word, the microcontroller can transmit up to 15 more data words. The EEPROM will respond with a zero after each data word received. The microcontroller must terminate the page write sequence with a stop condition (refer to Page write timing).

The data word address lower four bits are internally incremented following the receipt of each data word. The higher data word address bits are not incremented, retaining the memory page row location.

- **Acknowledge polling**  
 To maximise bus throughput, one technique is to allow the master to poll for an acknowledge signal after the start condition and the control byte for a write command have been sent. If the device is still busy implementing its write cycle, then no ACK will be returned. The master can send the next read/write command when the ACK signal has finally been received.

- **Write protect**  
 The HT24LC16 has a write-protect function and programming will then be inhibited when the WP pin is connected to VCC. Under this mode, the HT24LC16 is used as a serial ROM.

- **Read operations**  
 The HT24LC16 supports three read operations, namely, current address read, random address read and sequential read. During read operation execution, the read/write select bit should be set to "1".

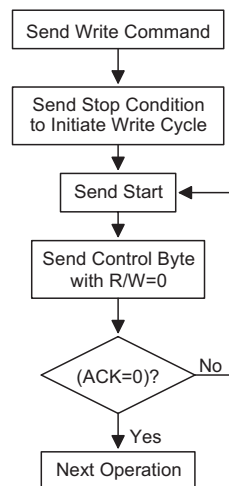

**Acknowledge Polling Flow**

- **Current address read**  
 The internal data word address counter maintains the last address accessed during the last read or write operation, incremented by one. This address stays valid between operations as long as the chip power is maintained. The address roll over during read from the last byte of the last memory page to the first byte of the first page. The address roll over during write from the last byte of the current page to the first byte of the same page. Once the device address with the read/write select bit set to one is clocked in and acknowledged by the EEPROM, the current address data word is serially clocked out. The microcontroller should respond with a "no ACK" signal (high) followed by a stop condition (refer to Current read timing).

- **Random read**  
 A random read requires a dummy byte write sequence to load in the data word address which is then clocked in and acknowledged by the EEPROM. The microcontroller must then generate another start condition. The microcontroller now initiates a current address read by sending a device address with the read/write select bit high. The EEPROM acknowledges the device address and serially clocks out the data word. The microcontroller should respond with a "no ACK" signal (high) followed by a stop condition (refer to Random read timing).

- Sequential read

Sequential reads are initiated by either a current address read or a random address read. After the microcontroller receives a data word, it responds with an acknowledgment. As long as the EEPROM receives an acknowledgment, it will continue to increment the data word address and serially clock

out sequential data words. When the memory address limit is reached, the data word address will roll over and the sequential read continues. The sequential read operation is terminated when the microcontroller responds with a "no ACK" signal (high) followed by a stop condition.

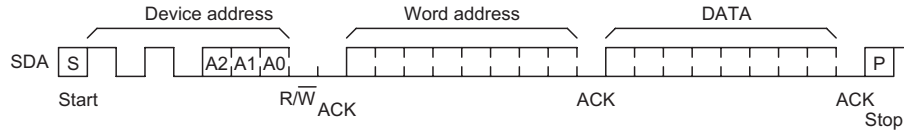

**Byte Write Timing**

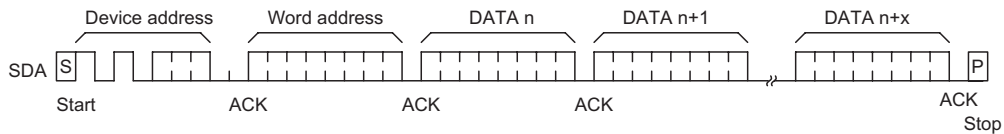

**Page Write Timing**

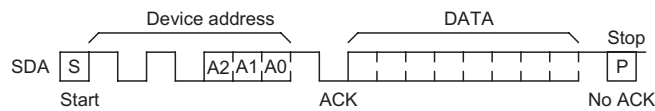

**Current Read Timing**

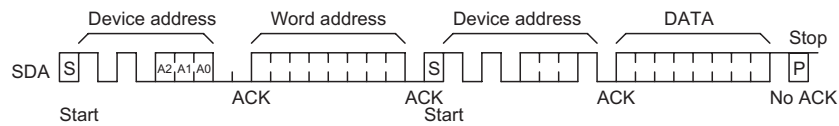

**Random Read Timing**

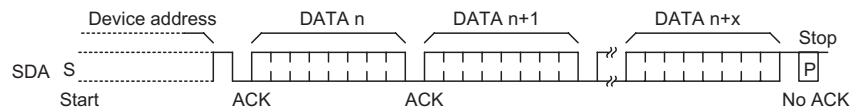

**Sequential Read Timing**

Timing Diagrams

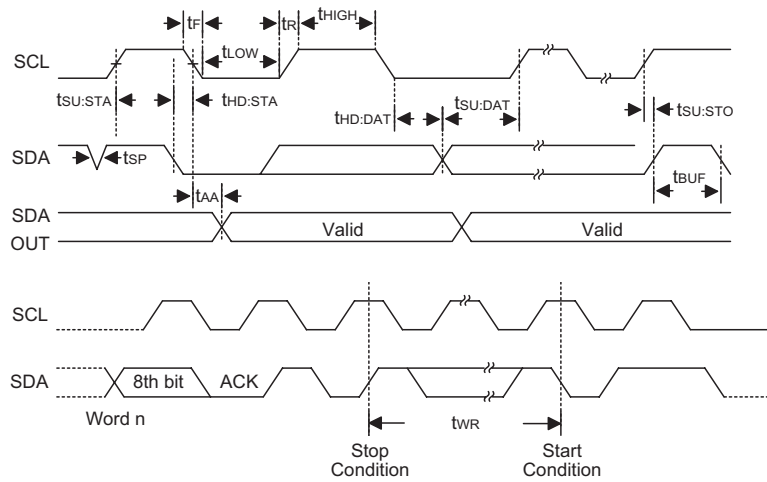

Note: The write cycle time  $t_{WR}$  is the time from a valid stop condition of a write sequence to the end of the valid start condition of sequential command.

## Package Information

Note that the package information provided here is for consultation purposes only. As this information may be updated at regular intervals users are reminded to consult the [Holtek website](#) for the latest version of the [Package/ Carton Information](#).

Additional supplementary information with regard to packaging is listed below. Click on the relevant section to be transferred to the relevant website page.

- Package Information (include Outline Dimensions, Product Tape and Reel Specifications)
- The Operation Instruction of Packing Materials
- Carton information

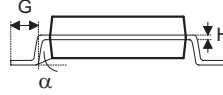
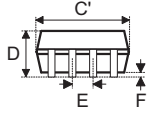
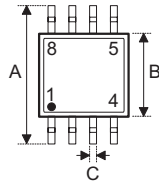

**8-pin SOP (150mil) Outline Dimensions**

Symbol	Dimensions in inch		
	Min.	Nom.	Max.
A	—	0.236 BSC	—
B	—	0.154 BSC	—
C	0.012	—	0.020
C'	—	0.193 BSC	—
D	—	—	0.069
E	—	0.050 BSC	—
F	0.004	—	0.010
G	0.016	—	0.050
H	0.004	—	0.010
$\alpha$	0°	—	8°

Symbol	Dimensions in mm		
	Min.	Nom.	Max.
A	—F	6.00 BSC	—
B	—	3.90 BSC	—
C	0.31	—	0.51
C'	—	4.90 BSC	—
D	—	—	1.75
E	—	1.27 BSC	—
F	0.10	—	0.25
G	0.40	—	1.27
H	0.10	—	0.25
$\alpha$	0°	—	8°

Copyright© 2020 by HOLTEK SEMICONDUCTOR INC.

The information appearing in this Data Sheet is believed to be accurate at the time of publication. However, Holtek assumes no responsibility arising from the use of the specifications described. The applications mentioned herein are used solely for the purpose of illustration and Holtek makes no warranty or representation that such applications will be suitable without further modification, nor recommends the use of its products for application that may present a risk to human life due to malfunction or otherwise. Holtek's products are not authorized for use as critical components in life support devices or systems. Holtek reserves the right to alter its products without prior notification. For the most up-to-date information, please visit our web site at <http://www.holtek.com>.