



5W Ultra small series power module

5M03/5M05/5M09/5M12/5M15/5M24



CONTENTS

1. Ultra small series power module	1
2. Product model	1
3. Product Features	1
4. Environmental conditions	2
5. Electrical characteristics	2
5.1. Input features	2
5.2. Output features (3.3V/1500mA)	3
5.3. Output features (5V/1000mA)	4
5.4. Output features (9V/560mA)	5
5.5. Output features (12V/450mA)	6
5.6. Output features (15V/333mA)	7
5.7. Output features (24V/208mA)	8
6. Input voltage and load characteristics	9
7. Working temperature and load characteristics	9
8. Typical application circuit	10
9. Safety features	11
9.1. Certification	11
9.2. Safety and electromagnetic compatibility	11
10. Marking, Packaging, Transportation, Storage	11
10.1. Marking	11
10.1.1. Product marking	11
10.1.2. Packing marking	11
10.2. Packaging	12
10.3. Transportation	12
10.4. Storage	12
11. Dimensions and weight	13

1. Ultra-small Series Power Module

The 5W ultra-small series module power supply is a small-volume, high-efficiency AC DC power module supply designed by Shenzhen Hi-Link Electronics Co.,Ltd. It has the advantages of global input voltage range, low temperature rise, low power consumption, high efficiency, high reliability and high safety isolation. It has been widely used in smart home, automation control, communications equipment, instrumentation and other industries.

2. Product Model

MODEL	Size (mm)	Output watt (W)	Output voltage (V)	Output current (mA)	Notes
HLK-5M03	38*23*18	5	3.3	1500	
HLK-5M05			5	1000	
HLK-5M09			9	560	
HLK-5M12			12	450	
HLK-5M15			15	333	
HLK-5M24			24	208	

3. Product features

1. Ultra-thin, ultra-small, smallest volume;
2. Global universal input voltage (85~265Vac)
3. Low power consumption, green environmental protection, no-load loss<0.1W
4. Low ripple, low noise
5. High output short circuit and over-current protection and self recovery
6. High efficiency, high power density
7. Input and output isolation voltage 3000Vac
8. 100% full load aging and testing
9. High reliability, long life design, continuous working time is greater than 100,000 hours;
10. Meet UL, CE requirements; product design to meet EMC and safety testing requirement;
11. Using high-quality environmentally friendly waterproof plastic potting, moisture, vibration, water and dust to meet IP65 standards
12. Economic solutions, cost-effective
13. Work without external circuit
14. 1 year quality guarantee period

4. Environmental conditions

Items	Technical Parameters	Units	Notes
Working temperature	-25—+60	°C	
Storage temperature	-40—+80	°C	
Relative humidity	5—95	%	
Thermal methods	Natural cooling		
Atmospheric pressure	80—106	Kpa	
Altitude	≤2000	m	
Vibration	Vibration coefficient 10~500Hz,2G10min./1cycle, 60min.each along X,Y,Z axes		Meets requirements for secondary road transportation

5. Electrical characteristics

5.1 Input features

Items	Technical Parameters	Units	Notes
Rated input voltage	100~240	Vac	
Input voltage range	85-265	Vac	Or 120-350Vdc
The maximum input current	≤0.2	A	
Input inrush current	≤10	A	
Input low start	≤50	mS	
Long-term reliability	MTBF≥100, 000	h	
External fuse recommended	1A / 250Vac or 10Ω wire wound resistance		Slow blow

Note: Tested at room temperature

5.2 Output features (3.3V/1500mA)

Items	Technical Parameters	Units	Notes
No-load rated output voltage	3.3±0.1	Vdc	
Full-load rated output voltage	3.3±0.2	Vdc	
Short time maximum output current	≥1800	mA	
Long time maximum output current	1500	mA	
Voltage regulation	±0.2	%	
Load regulation	±0.5	%	
Input low voltage efficiency	V _{in} =115Vac, Output full load≥69	%	
Input high voltage efficiency	V _{in} =230Vac, Output full load≥70	%	
Output ripple and noise (mVp-p)	≤100 Rated input voltage, output full load. With 20MHz bandwidth oscilloscope, Load side 10uF and 0.1uF capacitance test.	mV	
Switching on/off overshoot amplitude	(Rated input voltage, output plus 10% load) ≤5	%V _O	
Output over-current protection	Output maximum load 110-150%	A	
Output short circuit protection	Direct short circuit in normal output and automatic return to normal operation after removal of short circuit		No-damage to the whole device

5.3 Output features (5V/1000mA)

Items	Technical Parameters	Units	Notes
No-load rated output voltage	5.0±0.1	Vdc	
Full load rated output voltage	5.0±0.2	Vdc	
Short-time maximum output current	≥1200	mA	
Long time maximum output current	1000	mA	
Voltage regulation	±0.2	%	
Load regulation	±0.5	%	
Input low voltage efficiency	Vin=115Vac, Output full load≥69	%	
Input high voltage efficiency	Vin=230Vac, Output full load≥70	%	
Output ripple and noise(mVp-p)	≤100 Rated input voltage, full output load. Using 20MHz bandwidth oscilloscope, Load side test with 10uF and 0.1uF capacitors	mV	
Switching on/off overshoot amplitude	(Rated input voltage, output plus 10% load) ≤5	%V _O	
Output over-current protection	Output maximum load 110-150%	A	
Output short circuit protection	Direct short circuit in normal output and automatic return to normal operation after removal of short circuit		No damage to the whole device

5.4 Output features (9V/560mA)

Items	Technical Parameters	Units	Notes
No-load rated output voltage	9.0±0.1	Vdc	
Full load rated output voltage	9.0±0.2	Vdc	
Short-time maximum output current	≥680	mA	
Long time maximum output current	560	mA	
Voltage regulation	±0.2	%	
Load regulation	±0.5	%	
Input low voltage efficiency	V _{in} =115Vac, Output full load≥69	%	
Input high voltage efficiency	V _{in} =230Vac, Output full load≥70	%	
Output ripple and noise(mVp-p)	≤100 Rated input voltage, full output load. Using 20MHz bandwidth oscilloscope, Load side and 10uF and 0.1uF capacitors are tested.	mV	
Switching on/off overshoot amplitude	(Rated input voltage, output plus 10% load) ≤5	%V _O	
Output over-current protection	Output maximum load 110-150%	A	
Output short circuit protection	Direct short circuit in normal output and automatic return to normal operation after removal of short circuit		No damage to the whole device

5.5 Output features (12V/450mA)

Items	Technical Parameters	Units	Notes
No-load rated output voltage	12.0±0.1	Vdc	
Full load rated output voltage	12.0±0.2	Vdc	
Short-time maximum output current	≥540	mA	
Long time maximum output current	450	mA	
Voltage regulation	±0.2	%	
Load regulation	±0.5	%	
Input low voltage efficiency	Vin=115Vac, Output full load≥69	%	
Input high voltage efficiency	Vin=230Vac, Output full load≥70	%	
Output ripple and noise(mVp-p)	≤120 Rated input voltage, full output load. Using 20MHz bandwidth oscilloscope, Load side and 10uF and 0.1uF capacitors are tested.	mV	
Switching on/off overshoot amplitude	(Rated input voltage, output plus 10% load) ≤5	%V _O	
Output over-current protection	Output maximum load 110-150%	A	
Output short circuit protection	Direct short circuit in normal output and automatic return to normal operation after removal of short circuit		No damage to the whole device

5.6 Output features (15V/333mA)

Items	Technical Parameters	Units	Notes
No-load rated output voltage	15.0±0.1	Vdc	
Full load rated output voltage	15.0±0.2	Vdc	
Short-time maximum output current	≥440	mA	
Long time maximum output current	333	mA	
Voltage regulation	±0.2	%	
Load regulation	±0.5	%	
Input low voltage efficiency	V _{in} =115Vac, Output full load≥69	%	
Input high voltage efficiency	V _{in} =230Vac, Output full load≥70	%	
Output ripple and noise(mVp-p)	≤120 Rated input voltage, full output load. Using 20MHz bandwidth oscilloscope, Load side and 10uF and 0.1uF capacitors are tested.	mV	
Switching on/off overshoot amplitude	(Rated input voltage, output plus 10% load) ≤5	%V _O	
Output over-current protection	Output maximum load 110-150%	A	
Output short circuit protection	Direct short circuit in normal output and automatic return to normal operation after removal of short circuit		No damage to the whole device

5.7 Output features (24V/208mA)

Items	Technical Parameters	Units	Notes
No-load rated output voltage	24.0±0.1	Vdc	
Full load rated output voltage	24.0±0.2	Vdc	
Short-time maximum output current	≥308	mA	
Long time maximum output current	208	mA	
Voltage regulation	±0.2	%	
Load regulation	±0.5	%	
Input low voltage efficiency	Vin=115Vac, Output full load≥69	%	
Input high voltage efficiency	Vin=230Vac, Output full load≥70	%	
Output ripple and noise(mVp-p)	≤150 Rated input voltage, full output load. Using 20MHz bandwidth oscilloscope, Load side and 10uF and 0.1uF capacitors are tested.	mV	
Switching on/off overshoot amplitude	(Rated input voltage, output plus 10% load) ≤5	%V _O	
Output over-current protection	Output maximum load 110-150%	A	
Output short circuit protection	Direct short circuit in normal output and automatic return to normal operation after removal of short circuit		No damage to the whole device

6. Input voltage and load characteristics

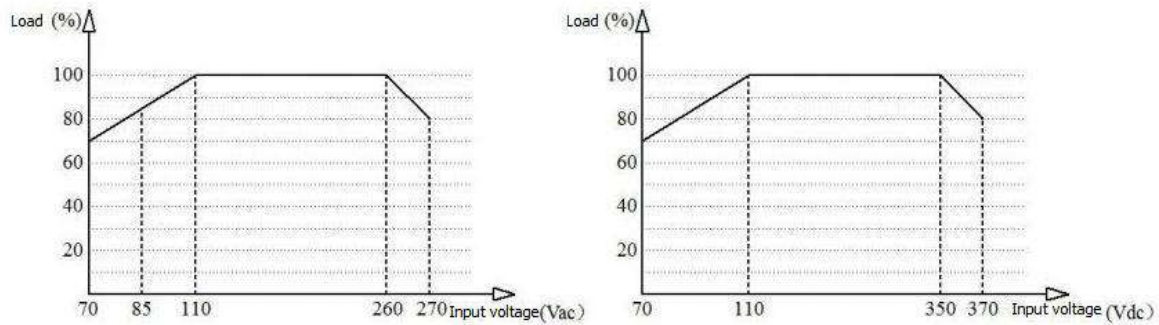

Input voltage and load characteristic curve
Input voltage and load characteristic curve

7. Working environment temperature and load characteristics

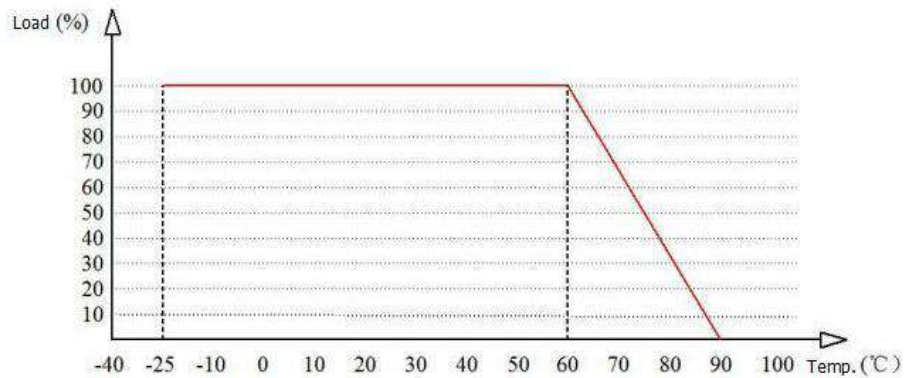

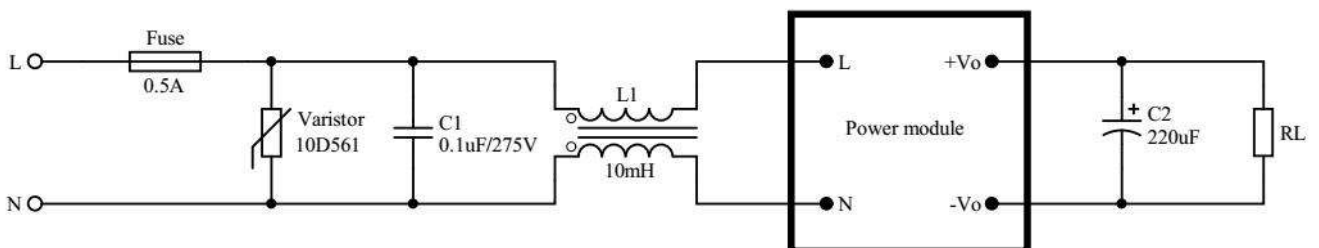

Environmental temperature and load characteristic curve

8. Typical application circuit

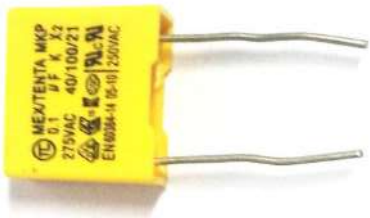

Input parts

Component number / recommended device	Functions	Recommended value
F1/Fuse	Protect the circuit from damage when the module is working wrong	1A/250Vac or 10Ω wire wound resistor,, Slow fuse
MOV1/Varistor	The cumulative surge is to protect the module from damage	10D561K
C1/Safety capacitance	Filtering, safety protection (EMC certification)	0.1uF/275Vac
L1/Common-mode inductance	EMI filtering	Sensible value10-30mH, Testing requirements:1KHZ / 0.3V current: 100-500mA
 <p>Safety capacitance</p>		 <p>Common-mode inductance</p>

Notes:

- Fuse and varistor are basic protective circuits (must be connected).
- If you need to pass the authentication/certification, the Safety capacitance and common-mode inductance could not be omitted.

Output parts

Component number / recommended device	Functions	Recommended value
C2/filter capacitor	output ripple can be controlled in 30mV after adding this capacitor	Aluminium electrolytic capacitance, capacity 100-220 UF, voltage reduction greater than 75%
RL/Load	Load	

Note: C2 filter capacitor can reduce the output ripple from the original 50mV to the 30mV.

9. Safety characteristic

9.1 Certification

Product design meets UL and CE safety certification requirements. (The UL and CE certifications are made by the customer and need to be designed according to the reference circuit.)

9.2 Safety and electromagnetic compatibility

- The input design adopts UL listed 1A / 250Vac slow-blow fuse or 10 Ω wire-wound resistor
- The PCB board is made of double-sided copper clad foil, and the material fire resistance grade is 94-V0 grade
- Safety standard meets UL1012,EN60950,UL60950
- Insulation voltage I/P-O/P:2500Vac
- Insulation resistance I/P-O/P>100M Ohms/500Vdc 25°C 70% RH
- Conduction and radiation meet EN55011, EN55022 (CISPR22)
- Electrostatic discharge IEC/EN 61000-4-2 level 4 8kV/15kV
- Radio frequency radiation immunity IEC/EN 61000-4-3

10. Marking, packaging, transportation, storage

10.1 Marking

10.1.1 Product marking

The product's unique bar code mark is attached to the appropriate location of the product to ensure traceability of the date of manufacture, product batch, etc. of each product. Its content meets the requirements of national standards and industry standards.

10.1.2 Packing marking

Product box marked with the name of the manufacturer, site, zip code, product model, factory year, month, day; Marked with "up", "moisture-proof" and "carefree" and other transport signs, all signs are in line with the provisions of GB 191.

10.2 Packaging

Products using special plastic boxes separated packaging, with anti-vibration function, and in line with the provisions of GB 3873.

10.3 Transportation

Packaged products can be transported by any means of transportation, should be awning in transit, there should be no violent vibration, impact, etc.

10.4 Storage

Product storage must meet the requirements of GB3873.

11. Dimensions and weight

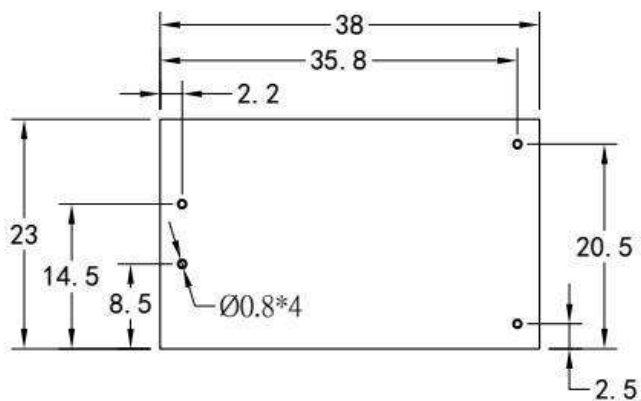

Pin function	
1	AC
2	AC
3	-V0
4	+V0
Weight: 32±1g	

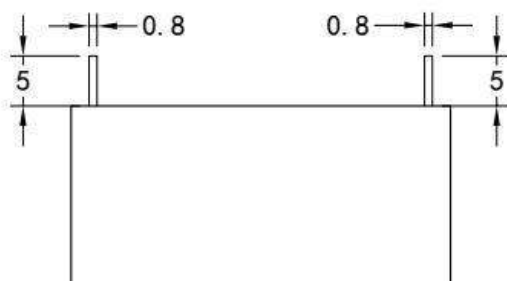
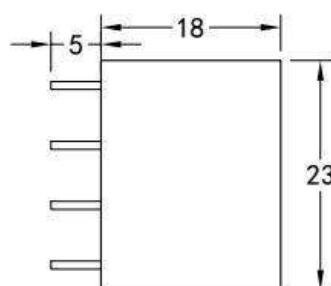
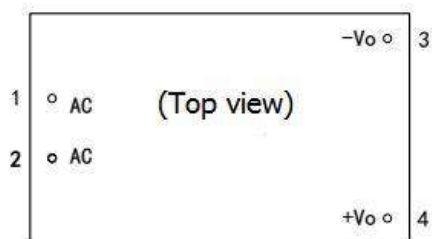

Dimensional error:

1. Length, width, height and pin pitch error $\pm 8\%$
2. Pin length error $\pm 1\text{mm}$
3. Pin diameter error -0.2mm

Unit: mm