

**BC846** TRANSISTOR (NPN)

**BC847**

**BC848**

### FEATURES

- Ideally suited for automatic insertion
- For switching and AF amplifier applications

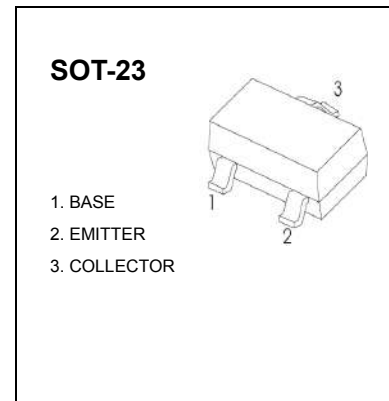

### MAXIMUM RATINGS (T<sub>a</sub>=25°C unless otherwise noted)

Symbol	Parameter	Value	Unit
V <sub>CB0</sub>	Collector-Base Voltage	BC846	80
		BC847	50
		BC848	30
V <sub>CEO</sub>	Collector-Emitter Voltage	BC846	65
		BC847	45
		BC848	30
V <sub>EBO</sub>	Emitter-Base Voltage	6	V
I <sub>c</sub>	Collector Current –Continuous	0.1	A
P <sub>c</sub>	Collector Power Dissipation	200	mW
R <sub>θJA</sub>	Thermal Resistance From Junction To Ambient	625	°C/W
T <sub>J</sub>	Junction Temperature	150	°C
T <sub>stg</sub>	Storage Temperature	-55~+150	°C

**ELECTRICAL CHARACTERISTICS (T<sub>a</sub>=25°C unless otherwise specified)**

Parameter	Symbol	Test conditions	Min	Typ	Max	Unit
Collector-base breakdown voltage	BC846	$I_C = 10\mu A, I_E = 0$	80			V
	BC847		50			
	BC848		30			
Collector-emitter breakdown voltage	BC846	$I_C = 10mA, I_B = 0$	65			V
	BC847		45			
	BC848		30			
Emitter-base breakdown voltage	$V_{EBO}$	$I_E = 10\mu A, I_C = 0$	6			V
Collector cut-off current	BC846	$V_{CB} = 70V, I_E = 0$ $V_{CB} = 50V, I_E = 0$ $V_{CB} = 30V, I_E = 0$			0.1	$\mu A$
	BC847					
	BC848					
Emitter cut-off current	$I_{EBO}$	$V_{EB} = 5V, I_C = 0$			0.1	$\mu A$
DC current gain	BC846A,847A,848A	$V_{CE} = 5V, I_C = 2mA$	110		220	
	BC846B,847B,848B		200		450	
	BC847C,BC848C		420		800	
Collector-emitter saturation voltage	$V_{CE(sat)}$	$I_C = 100mA, I_B = 5mA$			0.5	V
Base-emitter saturation voltage	$V_{BE(sat)}$	$I_C = 100mA, I_B = 5mA$			1.1	V
Transition frequency	$f_T$	$V_{CE} = 5V, I_C = 10mA$ $f = 100MHz$	100			MHz
Collector output capacitance	$C_{ob}$	$V_{CB} = 10V, f = 1MHz$			4.5	pF

### Typical Characteristics

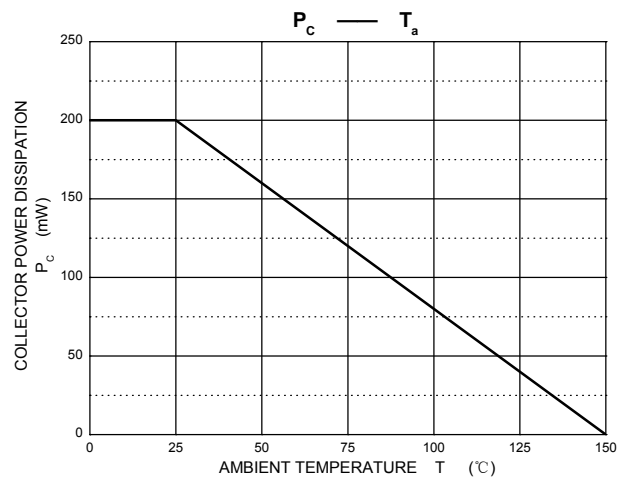
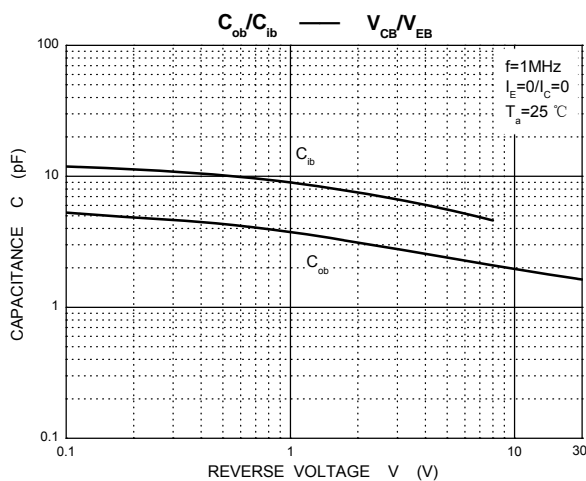
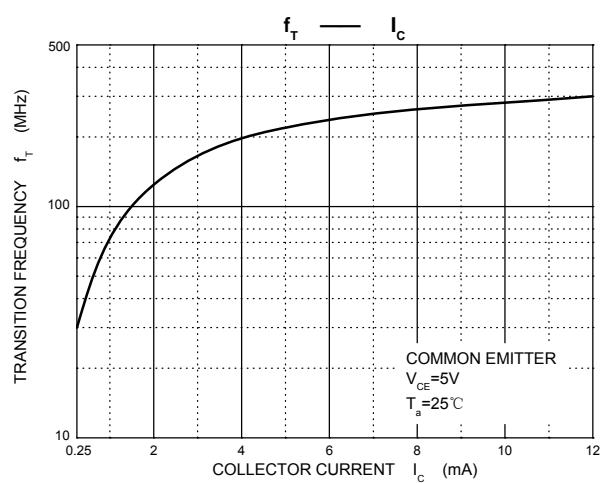
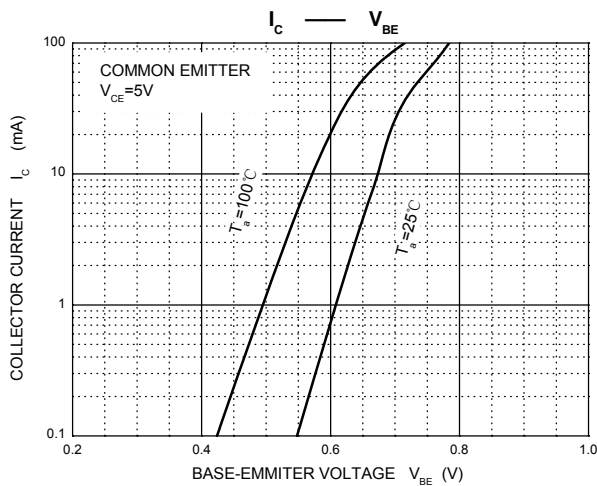
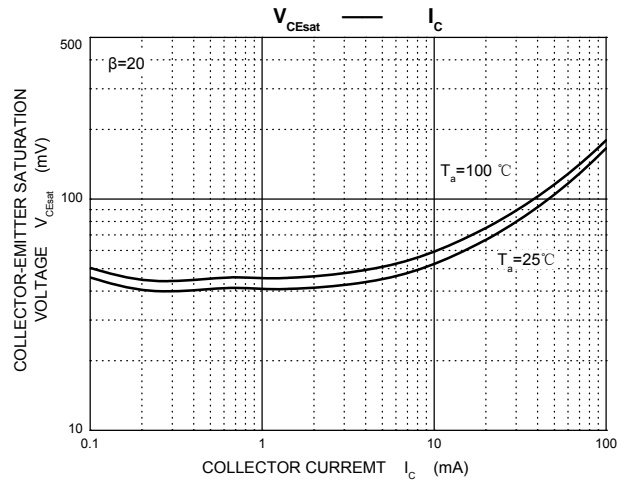
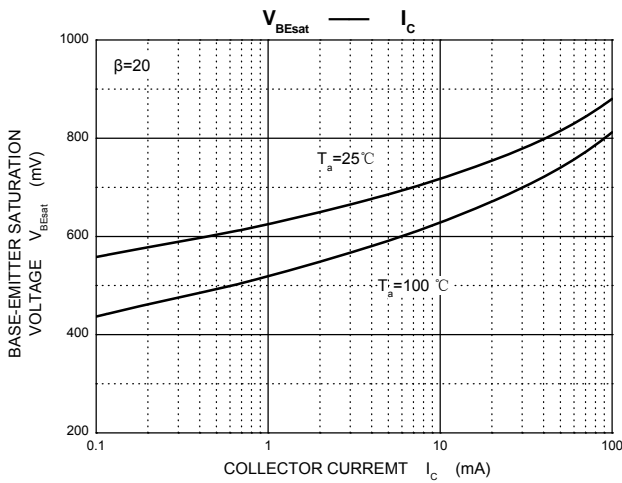
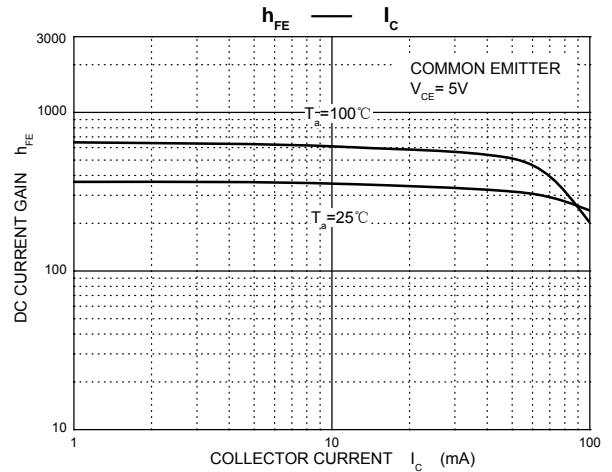
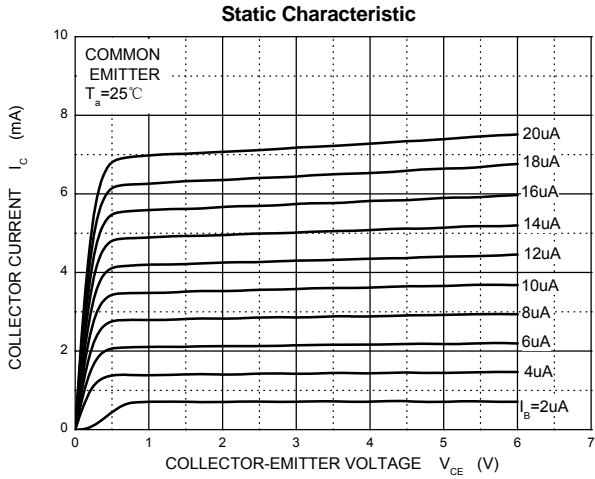

## SOT-23 Package Outline Dimensions

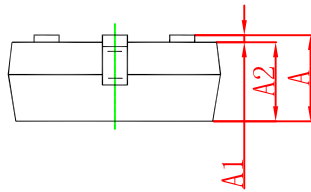
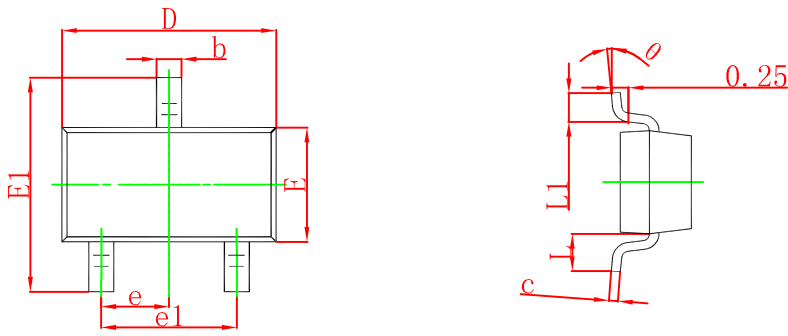

Symbol	Dimensions In Millimeters		Dimensions In Inches	
	Min	Max	Min	Max
A	0.900	1.150	0.035	0.045
A1	0.000	0.100	0.000	0.004
A2	0.900	1.050	0.035	0.041
b	0.300	0.500	0.012	0.020
c	0.080	0.150	0.003	0.006
D	2.800	3.000	0.110	0.118
E	1.200	1.400	0.047	0.055
E1	2.250	2.550	0.089	0.100
e	0.950 TYP		0.037 TYP	
e1	1.800	2.000	0.071	0.079
L	0.550 REF		0.022 REF	
L1	0.300	0.500	0.012	0.020
θ	0°	8°	0°	8°

## SOT-23 Suggested Pad Layout

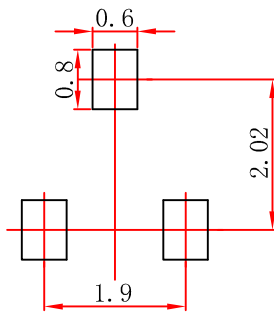

**Note:**

1. Controlling dimension: in millimeters.
2. General tolerance:  $\pm 0.05\text{mm}$ .
3. The pad layout is for reference purposes only.

### SOT-23 Tape and Reel

#### SOT-23 Embossed Carrier Tape

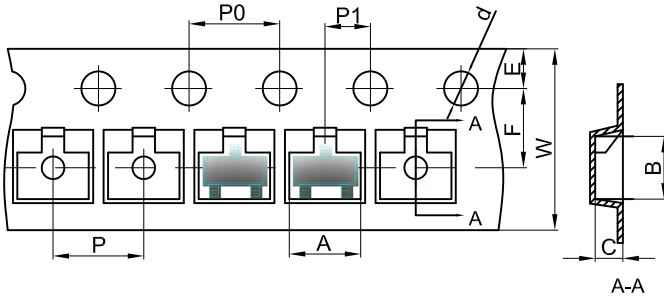

#### Packaging Description:

SOT-23 parts are shipped in tape. The carrier tape is made from a dissipative (carbon filled) polycarbonate resin. The cover tape is a multilayer film (Heat Activated Adhesive in nature) primarily composed of polyester film, adhesive layer, sealant, and anti-static sprayed agent. These reeled parts in standard option are shipped with 3,000 units per 7" or 17.8cm diameter reel. The reels are clear in color and is made of polystyrene plastic (anti-static coated).

Dimensions are in millimeter

Pkg type	A	B	C	d	E	F	P0	P	P1	W
SOT-23	3.15	2.77	1.22	Ø1.50	1.75	3.50	4.00	4.00	2.00	8.00

#### SOT-23 Tape Leader and Trailer

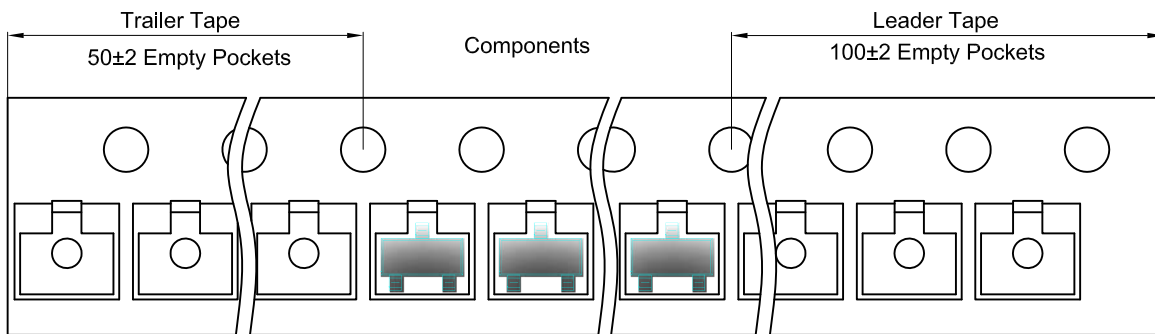

#### SOT-23 Reel

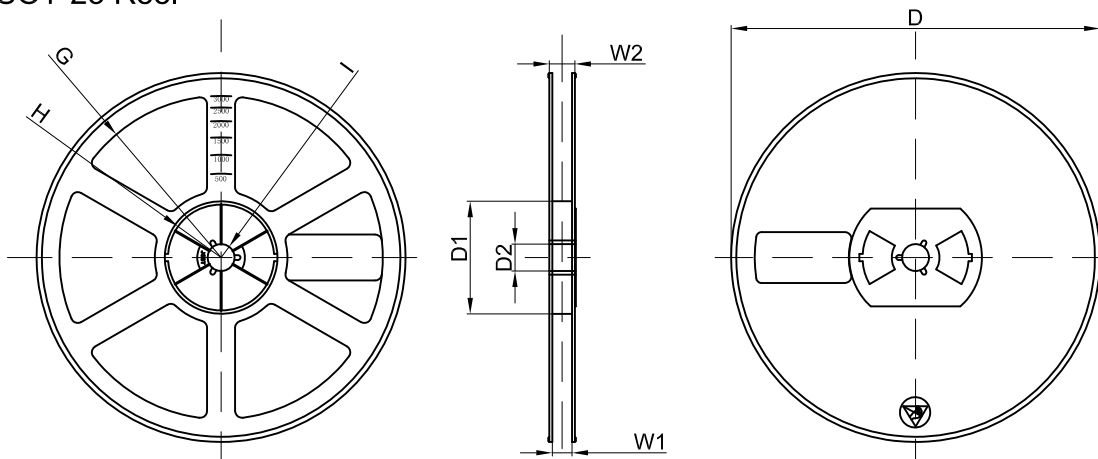

Dimensions are in millimeter

Reel Option	D	D1	D2	G	H	I	W1	W2
7" Dia	Ø178.00	54.40	13.00	R78.00	R25.60	R6.50	9.50	12.30

REEL	Reel Size	Box	Box Size(mm)	Carton	Carton Size(mm)	G.W.(kg)
3000 pcs	7 inch	45,000 pcs	203×203×195	180,000 pcs	438×438×220	