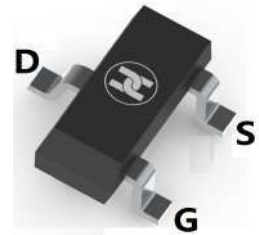
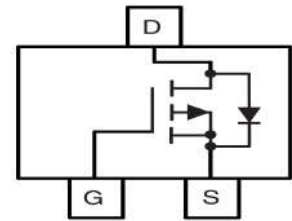

P-Channel Power MOSFET
FEATURES

- $V_{DS} = -20V, R_{DS(ON)} \leq 65m\Omega @ V_{GS} = -4.5V, I_D = -3.7A$
- Ultra Low On-Resistance
- P-Channel MOSFET
- Fast Switching

SOT-23

MECHANICAL DATA

- Case: SOT-23
- Case Material: Molded Plastic. UL flammability
- Classification Rating: 94V-0
- Weight: 0.008 grams (approximate)

Absolute Maximum Ratings

	Parameter	Max.	Units
V_{DS}	Drain- Source Voltage	-20	V
$I_D @ T_A = 25^\circ C$	Continuous Drain Current, $V_{GS} @ -4.5V$	-3.7	A
$I_D @ T_A = 70^\circ C$	Continuous Drain Current, $V_{GS} @ -4.5V$	-2.2	
I_{DM}	Pulsed Drain Current ①	-22	
$P_D @ T_A = 25^\circ C$	Power Dissipation	1.3	W
$P_D @ T_A = 70^\circ C$	Power Dissipation	0.8	
	Linear Derating Factor	0.01	
E_{AS}	Single Pulse Avalanche Energy④	11	mJ
V_{GS}	Gate-to-Source Voltage	± 12	V
T_J, T_{STG}	Junction and Storage Temperature Range	-55 to + 150	$^\circ C$

Thermal Resistance

	Parameter	Typ.	Max.	Units
$R_{\theta JA}$	Maximum Junction-to-Ambient③	75	100	$^\circ C/W$

Electrical Characteristics @ $T_J = 25^\circ C$ (unless otherwise specified)

	Parameter	Min.	Typ.	Max.	Units	Conditions
$V_{(BR)DSS}$	Drain-to-Source Breakdown Voltage	-20	—	—	V	$V_{GS} = 0V, I_D = -250\mu A$
$\Delta V_{(BR)DSS}/\Delta T_J$	Breakdown Voltage Temp. Coefficient	—	-0.009	—	$V/^\circ C$	Reference to $25^\circ C, I_D = -1mA$ ②
$R_{DS(on)}$	Static Drain-to-Source On-Resistance	—	0.050	0.065	Ω	$V_{GS} = -4.5V, I_D = -3.7A$ ②
		—	0.080	0.135		$V_{GS} = -2.5V, I_D = -3.1A$ ②
$V_{GS(th)}$	Gate Threshold Voltage	-0.40	-0.55	-1.2	V	$V_{DS} = V_{GS}, I_D = -250\mu A$
g_{fs}	Forward Transconductance	6.0	—	—	S	$V_{DS} = -10V, I_D = -3.7A$ ②
I_{DSS}	Drain-to-Source Leakage Current	—	—	-1.0	μA	$V_{DS} = -20V, V_{GS} = 0V$
		—	—	-25		$V_{DS} = -20V, V_{GS} = 0V, T_J = 70^\circ C$
I_{GSS}	Gate-to-Source Forward Leakage	—	—	-100	nA	$V_{GS} = -12V$
	Gate-to-Source Reverse Leakage	—	—	100		$V_{GS} = 12V$
Q_g	Total Gate Charge	—	8.0	12	nC	$I_D = -3.7A$
Q_{gs}	Gate-to-Source Charge	—	1.2	1.8		$V_{DS} = -10V$
Q_{gd}	Gate-to-Drain ("Miller") Charge	—	2.8	4.2		$V_{GS} = -5.0V$ ②
$t_{d(on)}$	Turn-On Delay Time	—	350	—	ns	$V_{DD} = -10V$
t_r	Rise Time	—	48	—		$I_D = -3.7A$
$t_{d(off)}$	Turn-Off Delay Time	—	588	—		$R_G = 89\Omega$
t_f	Fall Time	—	381	—		$R_D = 2.7\Omega$
C_{iss}	Input Capacitance	—	633	—	pF	$V_{GS} = 0V$
C_{oss}	Output Capacitance	—	145	—		$V_{DS} = -10V$
C_{rss}	Reverse Transfer Capacitance	—	110	—		$f = 1.0MHz$

IRLML6402

Source-Drain Ratings and Characteristics

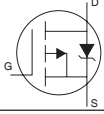
	Parameter	Min.	Typ.	Max.	Units	Conditions
I_S	Continuous Source Current (Body Diode)	—	—	-1.3	A	MOSFET symbol showing the integral reverse p-n junction diode. 
I_{SM}	Pulsed Source Current (Body Diode) ①	—	—	-22		
V_{SD}	Diode Forward Voltage	—	—	-1.2	V	$T_J = 25^\circ\text{C}$, $I_S = -1.0\text{A}$, $V_{GS} = 0\text{V}$ ②
t_{rr}	Reverse Recovery Time	—	29	43	ns	$T_J = 25^\circ\text{C}$, $I_F = -1.0\text{A}$
Q_{rr}	Reverse Recovery Charge	—	11	17	nC	$di/dt = -100\text{A}/\mu\text{s}$ ②

Notes:

- ① Repetitive rating; pulse width limited by max. junction temperature.
- ② Pulse width $\leq 400\mu\text{s}$; duty cycle $\leq 2\%$.
- ③ Surface mounted on 1" square single layer 1oz. copper FR4 board, steady state.
- ④ Starting $T_J = 25^\circ\text{C}$, $L = 1.65\text{mH}$
 $R_G = 25\Omega$, $I_{AS} = -3.7\text{A}$.

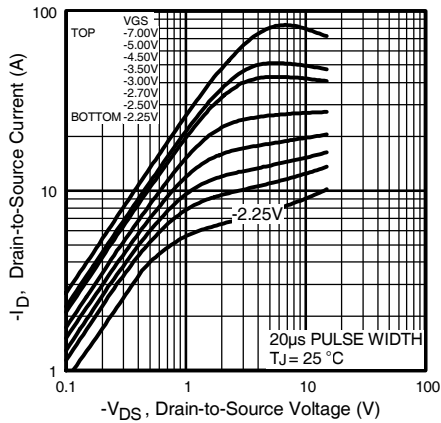

Fig 1. Typical Output Characteristics

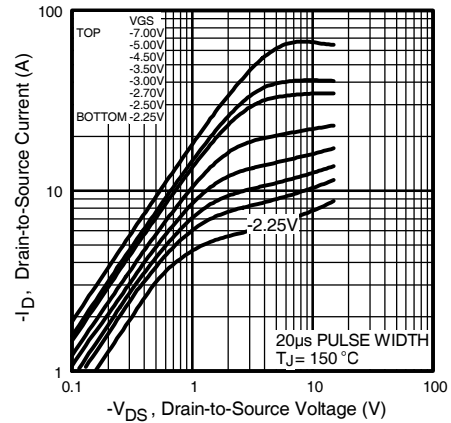

Fig 2. Typical Output Characteristics

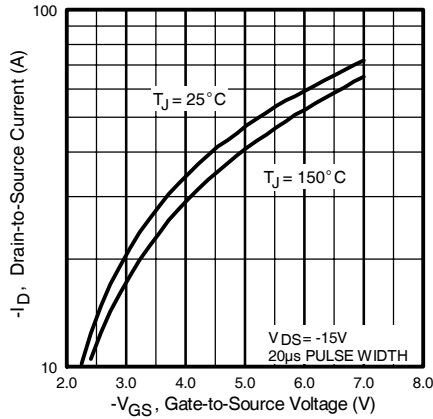

Fig 3. Typical Transfer Characteristics

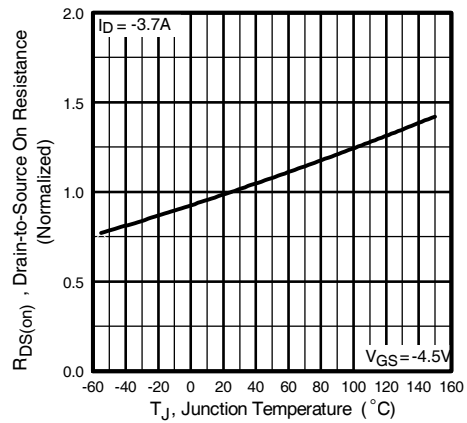

Fig 4. Normalized On-Resistance Vs. Temperature

IRLML6402

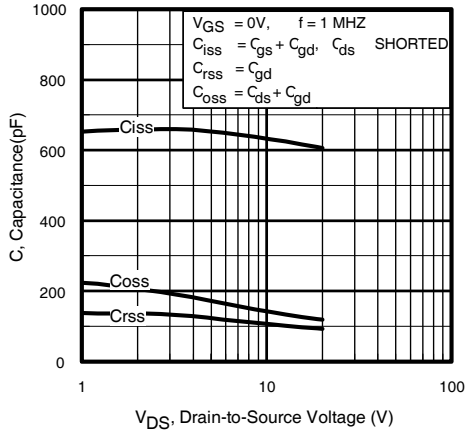

Fig 5. Typical Capacitance Vs. Drain-to-Source Voltage

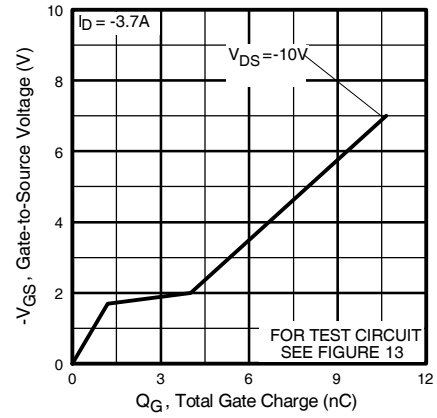

Fig 6. Typical Gate Charge Vs. Gate-to-Source Voltage

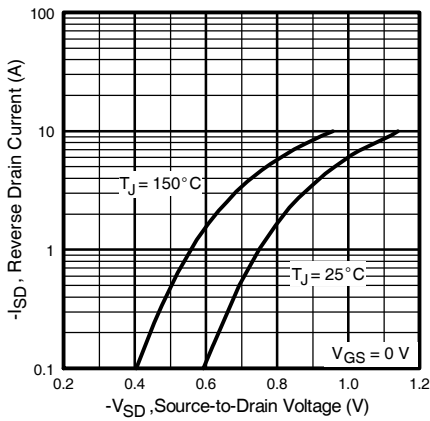

Fig 7. Typical Source-Drain Diode Forward Voltage

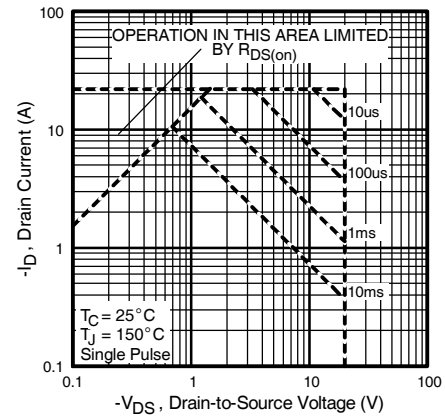

Fig 8. Maximum Safe Operating Area

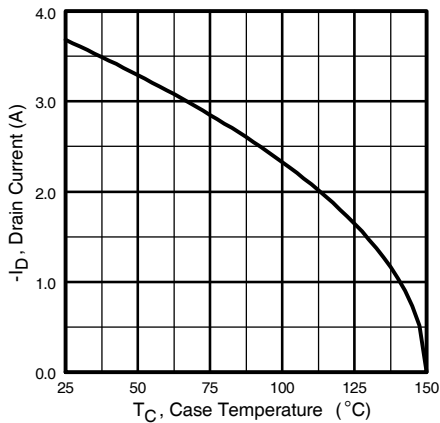

Fig 9. Maximum Drain Current Vs. Case Temperature

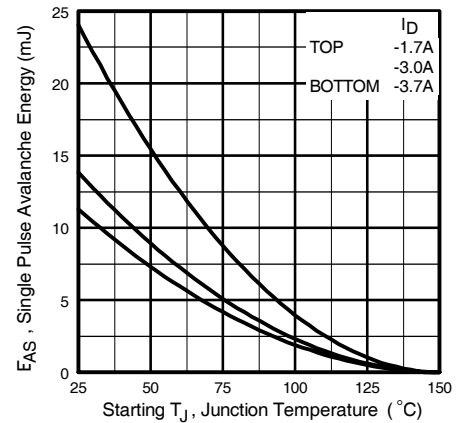

Fig 10. Maximum Avalanche Energy Vs. Drain Current

IRLML6402

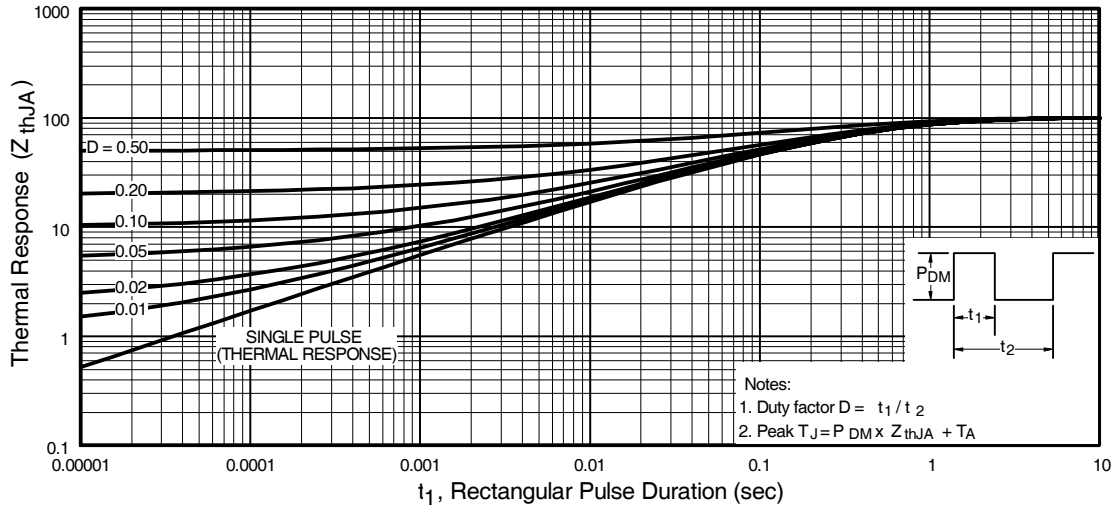

Fig 11. Maximum Effective Transient Thermal Impedance, Junction-to-Ambient

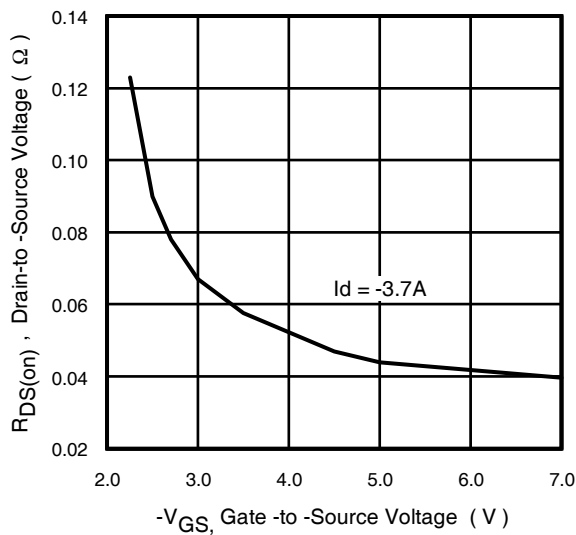

Fig 12. Typical On-Resistance Vs. Gate Voltage

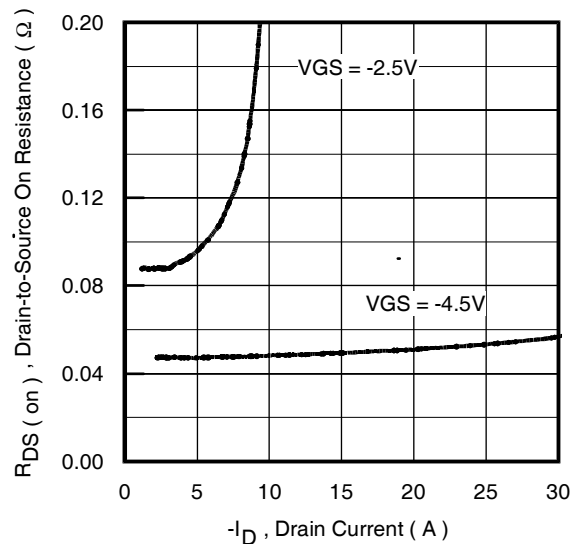
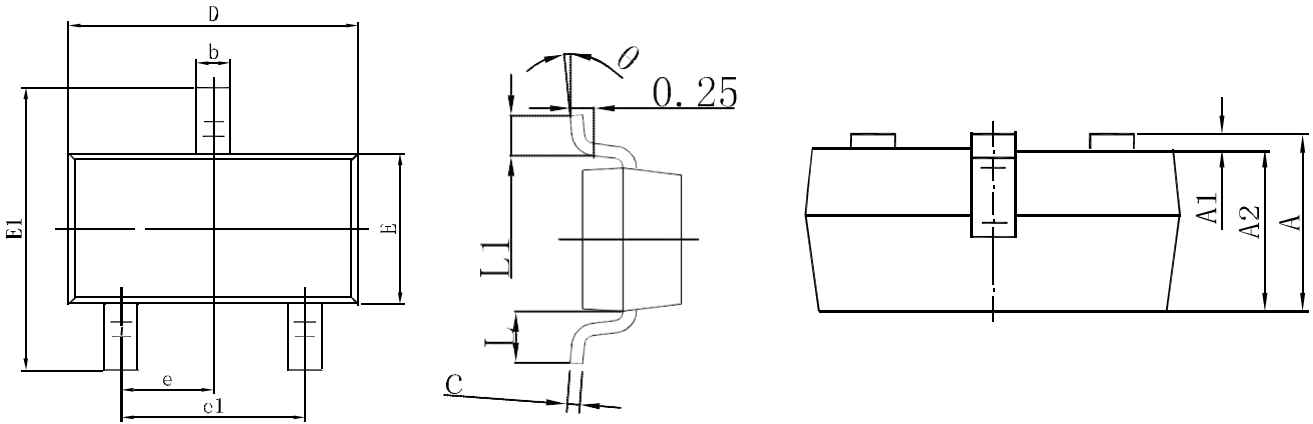
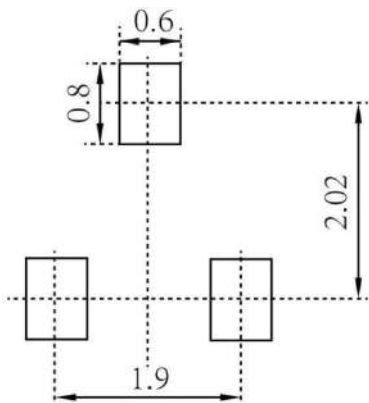

Fig 13. Typical On-Resistance Vs. Drain Current

P-Channel Power MOSFET
SOT-23 Package Outline Dimensions

Symbol	Dimensions In Millimeters		Dimensions In Inches	
	Min.	Max.	Min.	Max.
A	0.900	1.150	0.035	0.045
A1	0.000	0.100	0.000	0.004
A2	0.900	1.050	0.035	0.041
b	0.300	0.500	0.012	0.020
c	0.080	0.150	0.003	0.006
D	2.800	3.000	0.110	0.118
E	1.200	1.400	0.047	0.055
E1	2.250	2.550	0.089	0.100
e	0.950 TYP		0.037 TYP	
e1	1.800	2.000	0.071	0.079
L	0.550 REF		0.022 REF	
L1	0.300	0.500	0.012	0.020
θ	0°	8°	0°	8°

SOT-23 Suggested Pad Layout

Note:

1. Controlling dimension: in millimeters
2. General tolerance: $\pm 0.05\text{mm}$
3. The pad layout is for reference purposes only

P-Channel Power MOSFET

SOT-23 Tape and Reel

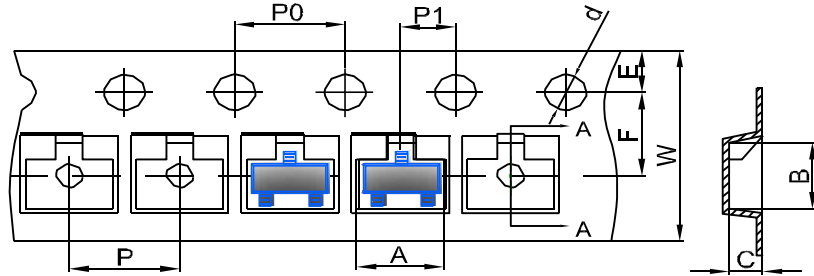
SOT-23 Embossed Carrier Tape



DIMENSIONS ARE IN MILLIMETER										
TYPE	A	B	C	d	E	F	P0	P	P1	W
SOT-23	3.15	2.77	1.22	Ø1.50	1.75	3.50	4.00	4.00	2.00	8.00
TOLERANCE	±0.1	±0.1	±0.1	±0.1	±0.1	±0.1	±0.1	±0.1	±0.1	±0.1

SOT-23 Tape Leader and Trailer

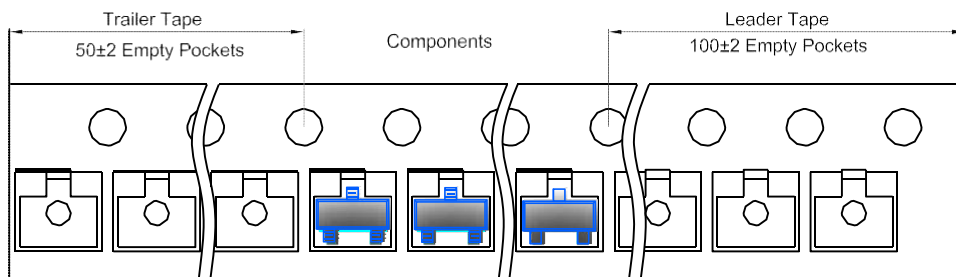

SOT-23 Reel

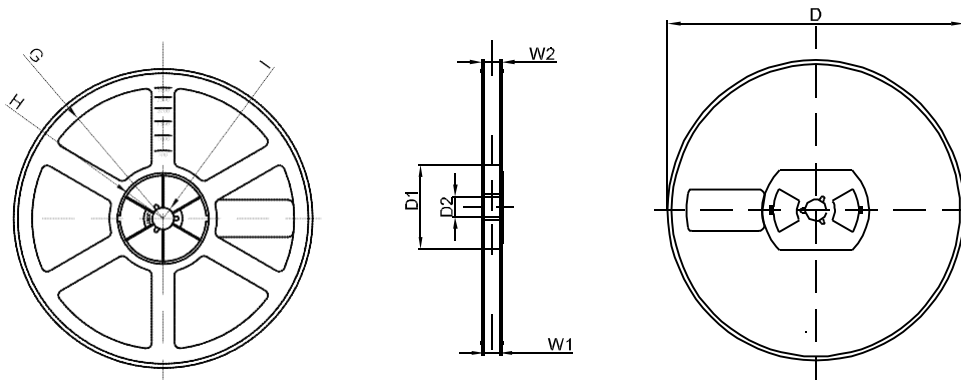

DIMENSIONS ARE IN MILLIMETER								
REEL OPTION	D	D1	D2	G	H	I	W1	W2
7" DIA	Ø178	54.40	13.00	R78	R25.60	R6.50	9.50	12.30
TOLERANCE	±2	±1	±1	±1	±1	±1	±1	±1