

通信继电器

HJR4102E

- Small size and low cost
- DIP standard terminals
- Surge Strength 1500V FCC68
- Sealed type available
- Conform to RoHS,ELV directive

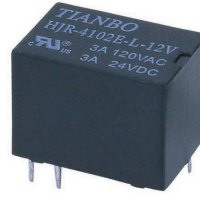

ORDERING CODE 订购代码

<u>HJR4102E</u>	D	—	<u>12VDC</u>	—	<u>S</u>	—	<u>Z</u>	<u>***</u>
1	2	3	4	5	6			
1. Relay Model 继电器型号	3. Coil Nominal Voltage 线圈额定电压		5. 触点转换形式					
2. Coil Power 线圈功率 N=0.45W, D=0.36W, L=0.2W	3,5,6,9,12,24,48VDC		Z: Form C; H: Form A					
4. Sealed 密封		6. 识别代码						

COIL DATA 线圈参数 (at 20°C)

Nominal Voltage 额定电压(VDC)	3	5	6	9	12	24	48	
Coil Resistance 线圈阻值($\Omega \pm 10\%$)	20	56	80	180	320	1280	5120	0.45W
Rated Current 额定电流(mA)	150	90	75	50	37.5	18.7	9	
Max Operate Voltage 最大吸合电压(VDC)	2.25	3.75	4.5	6.75	9	18	36	
Min Release Voltage 最小释放电压(VDC)	0.3	0.5	0.6	0.9	1.2	2.4	4.8	
Coil Resistance 线圈阻值($\Omega \pm 10\%$)	25	69	100	225	400	1600	6400	0.36W
Rated Current 额定电流(mA)	120	71.4	60	40	30	15	7.5	
Max Operate Voltage 最大吸合电压(VDC)	2.25	3.75	4.5	6.75	9	18	36	
Min Release Voltage 最小释放电压(VDC)	0.3	0.5	0.6	0.9	1.2	2.4	4.8	
Coil Resistance 线圈阻值($\Omega \pm 10\%$)	45	125	180	405	720	2880	/	0.2W
Rated Current 额定电流(mA)	66.7	40	33.3	22.2	16.7	8.3	/	
Max Operate Voltage 最大吸合电压(VDC)	2.25	3.75	4.5	6.75	9	18	/	
Min Release Voltage 最小释放电压(VDC)	0.3	0.5	0.6	0.9	1.2	2.4	/	
Max Applicable Voltage 最大过载电压	70°C时额定电压的130%，23°C时额定电压的170%							

CONTACT DATA 触点参数

Contact Form 触点形式	1H/1Z
Contact Material 触点材料	Silver Alloy
Load 负载	Resistive load(COS Φ =1)
Contact Ratings 触点负载	3A 120VAC/24VDC 1A 250VAC(TUV)
Minimum load 最小负载	1mA 5VDC
Max Switching Voltage 最大转换电压	240VAC/60VDC
Max Switching Current 最大转换电流	5A
Max Switching Power 最大转换功率	360VA/90W
Contact Resistance 接触电阻	100m Ω Max at 6VDC 1A
Life Expectancy 寿命	Electrical 电气寿命: 100,000 Operations(at 30 Operations/minute)
	Mechanical 机械寿命: 10,000,000 Operations(at 3000 Operations/minute)

■ CHARACTERISTICS DATA 性能参数

Insulation Resistance 绝缘阻值	100M Ω Min at 500VDC
Dielectric Strength Between Open Contacts 触点间耐压	500VAC(for one minute)
Between Contacts and coil 触点与线圈间耐压	1000VAC(for one minute) or 1500VAC(for one minute)
Operate Time 吸合时间	5ms
Release Time 释放时间	5ms
Temperature Range 环境温度	-30 $^{\circ}$ C to +85 $^{\circ}$ C
Shock Resistance 冲击	Operating Extremes 动作极限: 10G
	Damage Limits 破坏极限: 50G
Vibration Resistance 振动	10-55Hz, 1.5mm
Max. switching frequency 最大转换频率	Mechanical: 18,000operations/hr
	Electrical: 1,800operations/hr
Humidity 湿度	40-85%
Weight 重量	Approx 3.5g
Safety Standard 安全标准	UL cUL TÜV CQC

■ APPROVED STANDARDS 安全标准

Model(型号)	Coiling rating (线圈电压)	Safety Standard (安全标准)	Contact rating (触点负载)
HJR4102E	3 to 48VDC	TÜV	3A 120VAC 3A 24VDC 1A 250VAC
		UL/cUL	3A 120VAC 3A 24VDC
		CQC	1A 250VAC 3A 120VAC

■ 波峰焊建议温度曲线

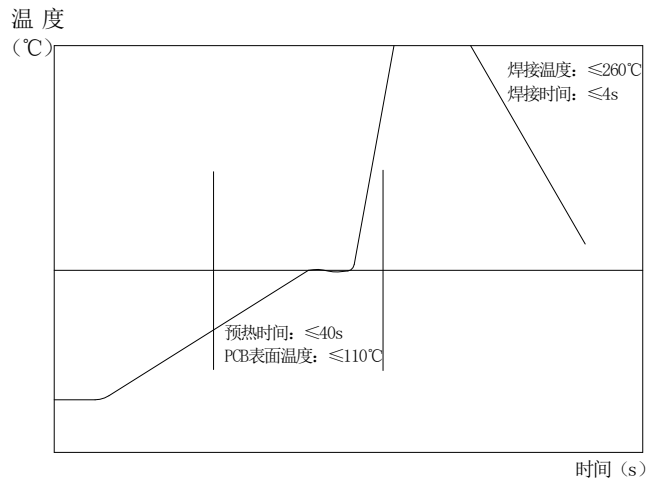

ENGINEERING DATA 设计参数

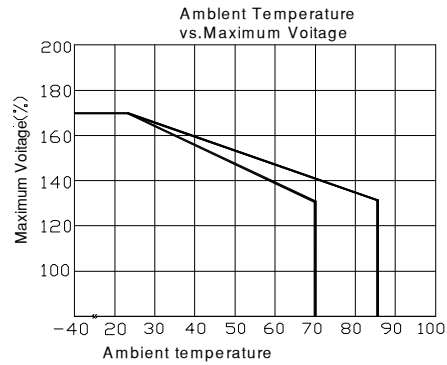
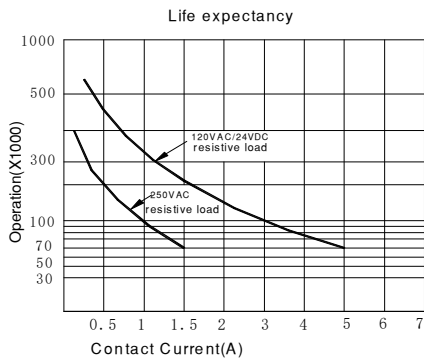
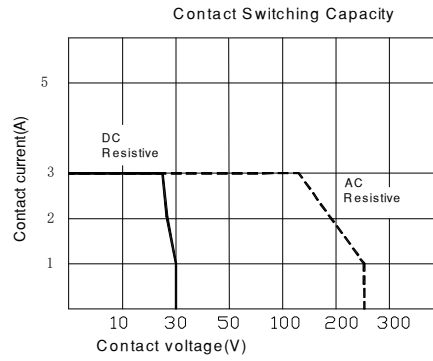
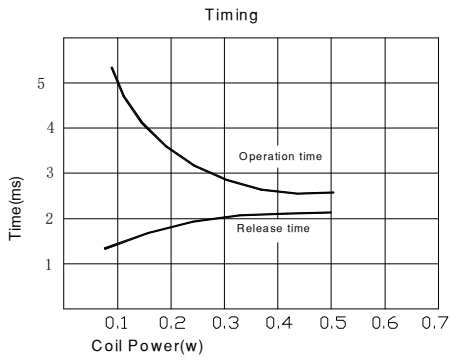

OVERALL AND MOUNTING DIMENSIONS 安装图

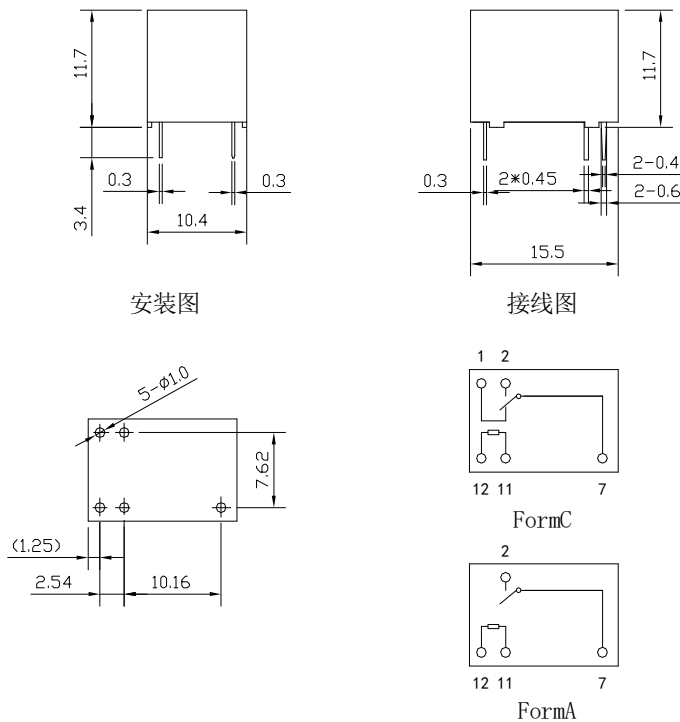

备注: 1) 产品部分外形尺寸中未注尺寸公差: 当外形尺寸 $\leq 1\text{mm}$ 时, 公差为 $\pm 0.2\text{mm}$; 当外形尺寸在 $1\sim 5\text{mm}$ 时, 公差为 $\pm 0.3\text{mm}$; 当外形尺寸 $> 5\text{mm}$ 时, 公差为 $\pm 0.4\text{mm}$ 。

2) 安装孔尺寸中未注尺寸公差均为 $\pm 0.1\text{mm}$ 。

声明:

本产品规格书仅供客户使用时参考, 如有更改, 恕不另行通知。